

Service
Service
Service

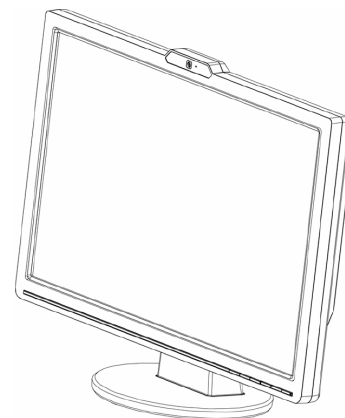

Service Manual

Horizontal Frequency
30-82 KHz

TABLE OF CONTENTS

Description	Page	Description	Page
Table Of Contents.....	1	6.Schematic.....	24
Revision List.....	2	6.1.Main Board.....	24
Important Safety Notice.....	3	6.2.Power Board.....	28
1.Monitor Specification.....	4	6.3.Audio Board.....	30
2.LCD Monitor Description.....	5	7.PCB Layout.....	31
3.Operation Instruction.....	6	7.1.Main Board.....	31
3.1.General Instructions.....	6	7.2.Power Board.....	32
3.2.Control Button.....	6	7.3.Audio Board.....	34
3.3.OSD Menu.....	9	7.4.Key Board.....	35
4.Input/Output Specification.....	14	8.Maintainability.....	36
4.1.Input Signal Connector.....	14	8.1.Equipments and Tools Requirement.....	36
4.2.Power Supply Requirements.....	15	8.2.Trouble Shooting.....	37
4.3.Factory Preset Display Modes.....	16	9.White-Balance, Luminance adjustment.....	43
4.4.Panel Specification.....	17	10.Monitor Exploded View.....	45
5.Block Diagram.....	19	11.BOM List.....	46
5.1.Software Flow Chart.....	19	12.Different Parts List.....	74
5.2.Electrical Block Diagram.....	21		

SAFETY NOTICE

ANY PERSON ATTEMPTING TO SERVICE THIS CHASSIS MUST FAMILIARIZE HIMSELF WITH THE CHASSIS AND BE AWARE OF THE NECESSARY SAFETY PRECAUTIONS TO BE USED WHEN SERVICING ELECTRONIC EQUIPMENT CONTAINING HIGH VOLTAGES.

CAUTION: USE A SEPARATE ISOLATION TRANSFORMER FOR THIS UNIT WHEN SERVICING

Important Safety Notice

Proper service and repair is important to the safe, reliable operation of all AOC Company Equipment. The service procedures recommended by AOC and described in this service manual are effective methods of performing service operations. Some of these service operations require the use of tools specially designed for the purpose. The special tools should be used when and as recommended.

It is important to note that this manual contains various CAUTIONS and NOTICES which should be carefully read in order to minimize the risk of personal injury to service personnel. The possibility exists that improper service methods may damage the equipment. It is also important to understand that these CAUTIONS and NOTICES ARE NOT EXHAUSTIVE. AOC could not possibly know, evaluate and advise the service trade of all conceivable ways in which service might be done or of the possible hazardous consequences of each way. Consequently, AOC has not undertaken any such broad evaluation. Accordingly, a servicer who uses a service procedure or tool which is not recommended by AOC must first satisfy himself thoroughly that neither his safety nor the safe operation of the equipment will be jeopardized by the service method selected.

Hereafter throughout this manual, AOC Company will be referred to as AOC.

WARNING

Use of substitute replacement parts, which do not have the same, specified safety characteristics may create shock, fire, or other hazards.

Under no circumstances should the original design be modified or altered without written permission from AOC. AOC assumes no liability, express or implied, arising out of any unauthorized modification of design. Servicer assumes all liability.

FOR PRODUCTS CONTAINING LASER:

DANGER-Invisible laser radiation when open AVOID DIRECT EXPOSURE TO BEAM.

CAUTION-Use of controls or adjustments or performance of procedures other than those specified herein may result in hazardous radiation exposure.

CAUTION -The use of optical instruments with this product will increase eye hazard.

TO ENSURE THE CONTINUED RELIABILITY OF THIS PRODUCT, USE ONLY ORIGINAL MANUFACTURER'S REPLACEMENT PARTS, WHICH ARE LISTED WITH THEIR PART NUMBERS IN THE PARTS LIST SECTION OF THIS SERVICE MANUAL.

Take care during handling the LCD module with backlight unit

- Must mount the module using mounting holes arranged in four corners.
- Do not press on the panel, edge of the frame strongly or electric shock as this will result in damage to the screen.
- Do not scratch or press on the panel with any sharp objects, such as pencil or pen as this may result in damage to the panel.
- Protect the module from the ESD as it may damage the electronic circuit (C-MOS).
- Make certain that treatment person's body is grounded through wristband.
- Do not leave the module in high temperature and in areas of high humidity for a long time.
- Avoid contact with water as it may a short circuit within the module.
- If the surface of panel becomes dirty, please wipe it off with a soft material. (Cleaning with a dirty or rough cloth may damage the panel.)

1. Monitor Specifications

LCD Panel	Driving system	TFT Color LCD
	Size	22"
	Pixel pitch	0.282mm(H)x 0.282mm(V)
	Response time (type)	5ms
	Viewable angle	170° (H) 160° (V)
	Video	R,G,B Analog Interface
Input	Sync. Type	H/V TTL
	H-Frequency	30kHz – 82kHz
	V-Frequency	56-76 Hz
Power Consumption	ON Mode	≤50W
	OFF Mode	≤1W
Webcam	Built-in USB2.0 1.3M	
Display Color	16.7M	
Dot Clock	160MHz	
Contrast Ratio	1000:1	
White Luminance	210cd/m ²	
Max. Resolution	1680 x 1050	
Plug & Play	VESA DDC2B™	
Power Source	100~240VAC, 47~63Hz	
Input Connector	D-Sub 15pin	
	DVI 22pin (only for VK222U)	
Input Video Signal	Analog:0.7Vp-p(standard),75 OHM, Positive	
Safety Certifications	UL/CUL , FCC, CE, Gost-R, BSMI,CCC,VCCI,C-Tick, CB, RoHS required,PSB, J-MOSS	
Maximum Screen Size	Horizontal : 473.76mm	
	Vertical: 296.1mm	
Environmental Considerations	Operating Temp: 0°C to 35°C	
	Storage Temp: -20°C to 60°C	
	Operating Humidity: 45% to 85%	

2. LCD Monitor Description

The LCD monitor will contain a main board, an audio board, a power board and a key board which house the flat panel control logic, brightness control logic and DDC.

The power board will provide AC to DC Inverter voltage to drive the backlight of panel and the main board chips each voltage.

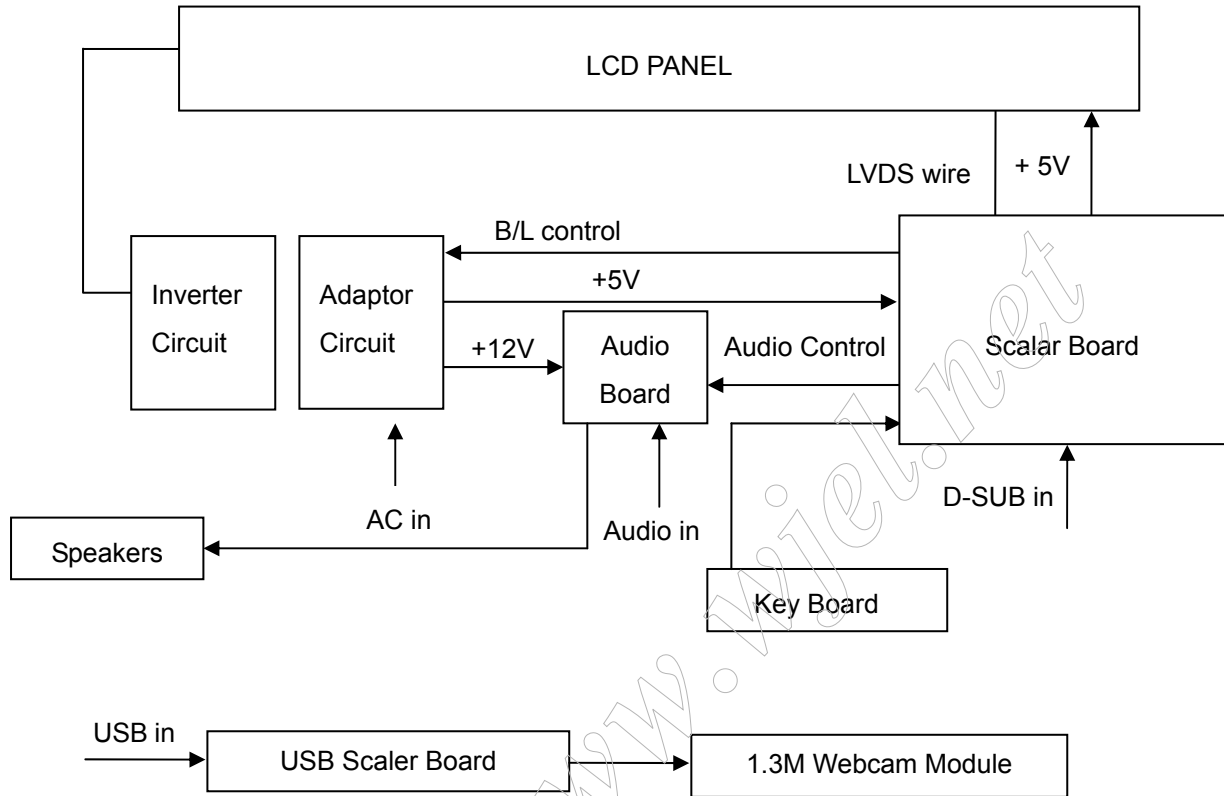

3. Operating Instructions

3.1 General Instructions

Press the power button to turn the monitor on or off. The other control buttons are located at the front of the panel of the monitor.

By changing these settings, the picture can be adjusted to your personal preferences.

- The power cord should be connected.
- Connect the video cable from the monitor to the video card.
- Press the power button to turn on the monitor, the power indicator will light up.

3.2 Control Buttons

for VK222U

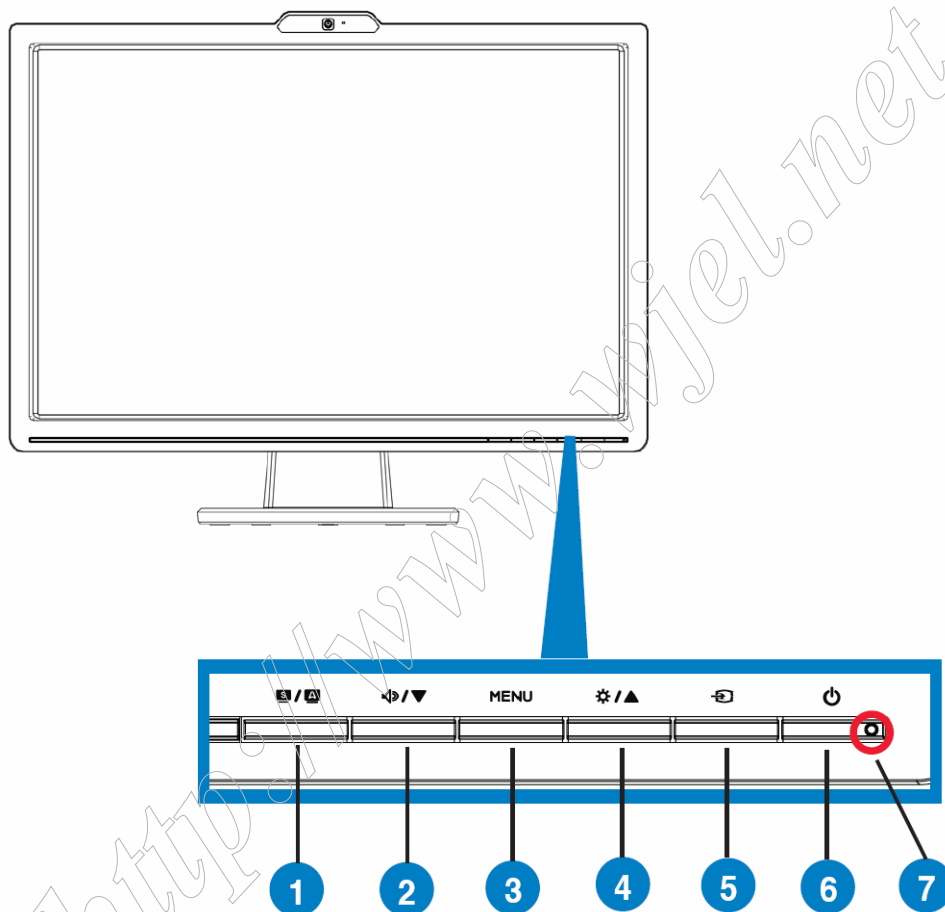

for VK222S

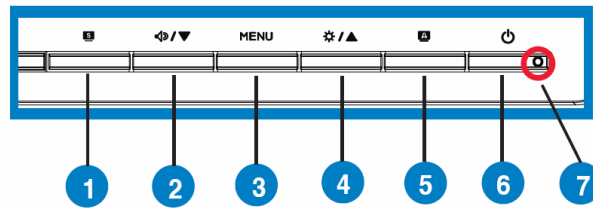

1. **S** button:
 - Use this hotkey to switch from five video preset modes (Game Mode, Night View Mode, Scenery Mode, Standard Mode, Theater Mode) with SPLENDID™ Video Enhancement Technology.
 - Exit the OSD menu or go back to the previous menu as the OSD menu is active.
2. **◀/▼** Button:
 - Press this button to decrease the value of the function selected or move to the next function.
 - This is also a hotkey for Volume adjustment.
3. **MENU** Button:
 - Press this button to enter/select the icon (function) highlighted while the OSD menu is activated.
4. **⚙/▲** Button:
 - Press this button to increase the value of the function selected or move to the previous function.
 - This is also a hotkey for Brightness adjustment.
5. **A** button:
 - Automatically adjust the image to its optimized position, clock, and phase by long pressing this button (for VGA mode only).
6. **⏻** Power button
 - Press this button to turn the monitor on/off.
7. **Power indicator**
 - The color definition of the power indicator is as the below table.

3.3 OSD Menu

3.3.1 How to Reconfigure

1. Press the MENU button to activate the OSD menu.



2. Press ▼ and ▲ to navigate through the functions. Highlight and activate the desired function by pressing the MENU button. If the function selected has a sub-menu, press ▼ and ▲ again to navigate through the sub-menu functions. Highlight and activate the desired sub-menu function by pressing the MENU button.
3. Press ▼ and ▲ to change the settings of the selected function.
4. To exit the OSD menu, press the **S** button. Repeat step 2 and step 3 to adjust any other function.

3.1.2 OSD Function Introduction

1. Splendid

This function contains five sub-functions you can select for your preference. Each mode has the Reset selection, allowing you to maintain your setting or return to the preset mode.



- **Scenery Mode:** best choice for scenery photo display with SPLENDID™ Video Enhancement.
- **Standard Mode:** best choice for document editing with SPLENDID™ Video Enhancement.
- **Theater Mode:** best choice for movie with SPLENDID™ Video Enhancement.
- **Game Mode:** best choice for game playing with SPLENDID™ Video Enhancement.
- **Night View Mode:** best choice for dark-scene game or movie with SPLENDID™ Video Enhancement.



- In the Standard Mode, the **Saturation** and ASCR functions are not user-configurable.
- In the other modes, the **sRGB** function is not user-configurable.

3.3.2 OSD Function Introduction

2. Image

You can adjust brightness, contrast, sharpness, saturation, position (VGA only), and focus (VGA only) from this main function.

VK221-P1

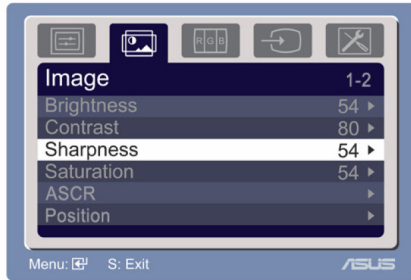

VK222 -P1

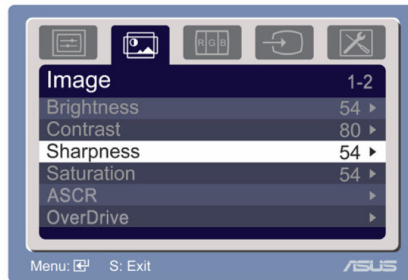

VK221-P2

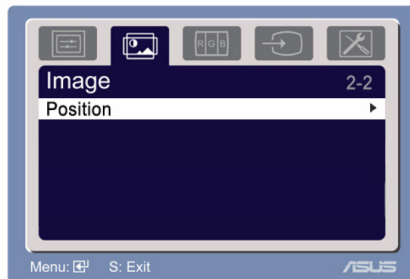

VK222 -P2

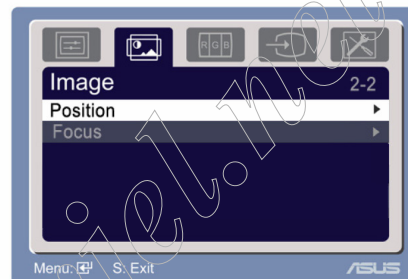

- Brightness: the adjusting range is from 0 to 100. ☀ is a hotkey to activate this function.
 - Contrast: the adjusting range is from 0 to 100.
 - Sharpness: the adjusting range is from 0 to 100.
 - Saturation: the adjusting range is from 0 to 100.
 - ASCR: Select YES or NO to enable or disable dynamic contrast ratio function.
 - Over Drive: To speed up the response time by Over drive technology. the adjusting range is from 0 to 100 (Not available for VK221S/D)
 - Position: adjusts the horizontal position (H-Position) and the vertical position (V-Position) of the image. The adjusting range is from 0 to 100.
 - Focus: reduces Horizontal-line noise and Vertical-line noise of the image by adjusting (Phase) and (Clock) separately. The adjusting range is from 0 to 100.
-
- Phase adjusts the phase of the pixel clock signal. With a wrong phase adjustment, the screen shows horizontal disturbances.
 - Clock (pixel frequency) controls the number of pixels scanned by one horizontal sweep. If the frequency is not correct, the screen shows vertical stripes and the image is not proportional.



3. Color

Select the image color you like from this function.

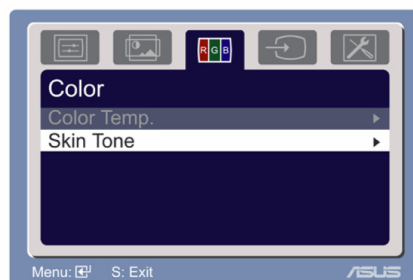

- Color Temp.: contains five color modes including Cool, Normal, Warm, sRGB, and User mode.
- Skin Tone: contains three color modes including Reddish, Natural, and Yellowish.



In the User mode, colors of R (Red), G (Green), and B (Blue) are user-configurable; the adjusting range is from 0-100.

4. Input Select

In this function, you can select VGA, DVI, HDMI input source.
(Only for some models)

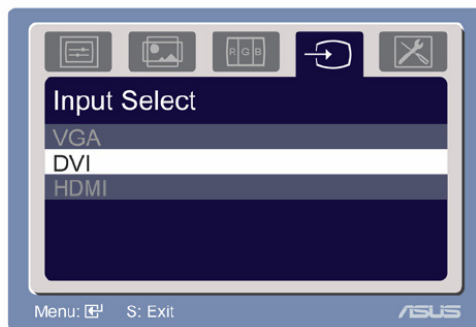

5. System Setup

Allow you to adjust the system.

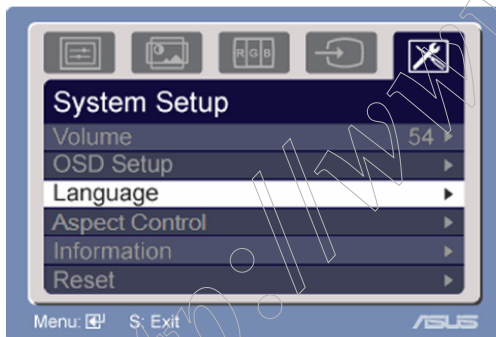

- Volume: the adjusting range is from 0 to 100.  is a hotkey to activate this function.
- OSD Setup: adjusts the horizontal position (H-Position) and the vertical position (V-Position) of the OSD. The adjusting range is from 0 to 100. In the OSD Timeout selection, you can adjust the OSD timeout from 10 to 120.
- Language: there are ten languages for your selection, including English, German, Italian, French, Dutch, Spanish, Russian, Traditional Chinese, Simplified Chinese, Japanese, and Korean.
- Aspect Controls: adjusts the aspect ratio to "Full" or "4:3".
- Information: shows the monitor information.
- Reset: "Yes" allows you to revert to the preset mode.

2. Image

You can adjust brightness, contrast, sharpness, saturation, position (VGA only), and focus (VGA only) from this main function.

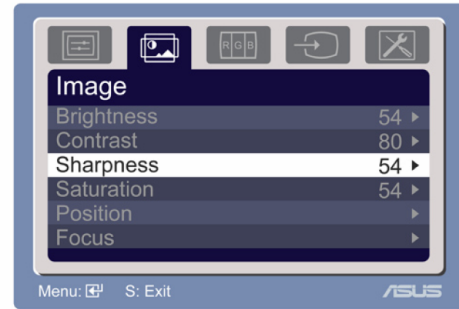

- Brightness: the adjusting range is from 0 to 100. + ▶ is a hotkey to activate this function.
- Contrast: the adjusting range is from 0 to 100.
- Sharpness: the adjusting range is from 0 to 100.
- Saturation: the adjusting range is from 0 to 100.
- Position: adjusts the horizontal position (H-Position) and the vertical position (V-Position) of the image. The adjusting range is from 0 to 100.
- Focus: reduces Horizontal-line noise and Vertical-line noise of the image by adjusting (Phase) and (Clock) separately. The adjusting range is from 0 to 100.



- Phase adjusts the phase of the pixel clock signal. With a wrong phase adjustment, the screen shows horizontal disturbances.
- Clock (pixel frequency) controls the number of pixels scanned by one horizontal sweep. If the frequency is not correct, the screen shows vertical stripes and the image is not proportional.

3. Color

Select the image color you like from this function.

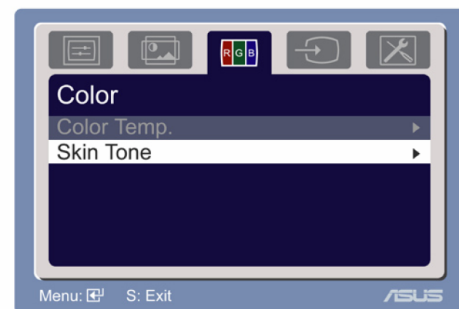

- Color Temp.: contains five color modes including Cool, Normal, Warm, sRGB, and User mode.
- Skin Tone: contains three color modes including Reddish, Natural, and Yellowish.



In the User mode, colors of R (Red), G (Green), and B (Blue) are user-configurable; the adjusting range is from 0-100.

4. Input Select

In this function, you can select either VGA or DVI input source.
(Only for some models)

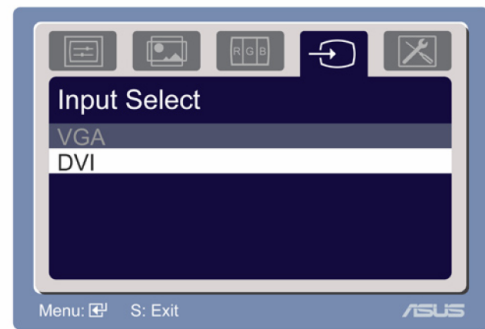

5. System Setup

Allow you to adjust the system.

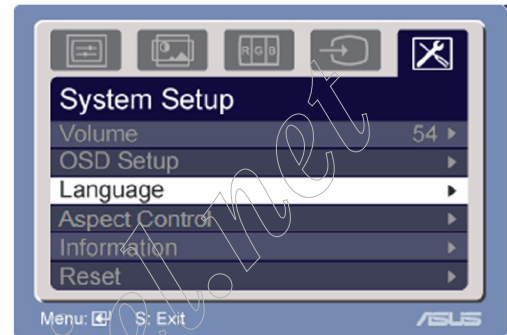

- Volume: the adjusting range is from 0 to 100. **[F5]** is a hotkey to activate this function.
- OSD Setup: adjusts the horizontal position (H-Position) and the vertical position (V-Position) of the OSD. The adjusting range is from 0 to 100. In the OSD Timeout selection, you can adjust the OSD timeout from 10 to 120.
- Language: there are ten languages for your selection, including English, German, Italian, French, Dutch, Spanish, Russian, Traditional Chinese, Simplified Chinese, Japanese, and Korean.
- Aspect Controls: adjusts the aspect ratio to "Full" or "4:3".
- Information: shows the monitor information.
- Reset: "Yes" allows you to revert to the preset mode.

4. Input/Output Specification

4.1 Input Signal Connector

Analog connectors

Pin No.	Description	Pin No.	Description
1.	Red Video	9.	+5V
2.	Green Video	10.	Logic Ground
3.	Blue Video	11.	Monitor Ground
4.	Monitor Ground	12.	DDC-Serial Data
5.	DDC-Return	13.	H-Sync
6.	Red Ground	14.	V-Sync
7.	Green Ground	15.	DDC-Serial Clock
8.	Blue Ground		

VGA connector layout

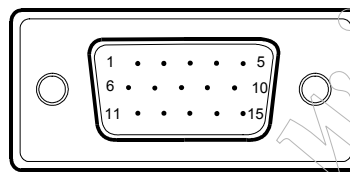

DVI connectors (only for VK222U)

Pin No.	Description	Pin No.	Description	Pin No.	Description
1.	RX2-	9.	R X1-	17.	RX0-
2.	RX2+	10.	RX1+	18.	RX0+
3.	RX2 Shield	11.	RX1 Shield	19.	RX0 Shield
4.	NC	12.	NC	20.	NC
5.	NC	13.	NC	21.	NC
6.	DDC Clock	14.	+5V Power	22.	RX Clock Shield
7.	DDC Data	15.	Ground	23.	RX Clock+
8.	NC	16.	Hot Plug Detection	24.	RX Clock-

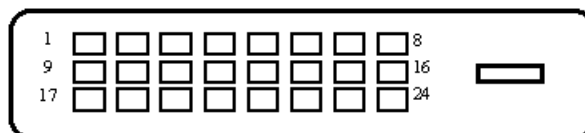

4.2 Power Supply Requirements

A/C Line voltage range	100 V ~ 240 V
A/C Line frequency range	50 ± 3Hz, 60 ± 3Hz
Input Voltage transients	90-264 voltage AC for 10 sec @40°C
Current	1.5A max at 100V; 0.8A max at 240 V
Peak surge current	< 60A peak at 240 VAC and cold starting < 30A peak at 120VAC and cold starting
Leakage current	< 3.5mA
Power line surge	No advance effects (no loss of information or defect) with a maximum of 1 half-wave missing per second

<http://www.wjel.net>

4.3 Factory Preset Display Modes

Mode	Resolution	H(KHz)	V(Hz)	Pixel(MHz)
VGA	640x480	31.469	60Hz	25.175
	640x480	37.861	72Hz	31.5
	640x480	37.5	75Hz	31.5
SVGA	800x600	35.156	56Hz	36
	800x600	37.879	60Hz	40
	800x600	48.077	72Hz	50
	800x600	46.875	75Hz	49.5
XGA	1024x768	48.363	60Hz	65
	1024x768	56.476	70Hz	75
	1024x768	60.023	75Hz	78.75
SXGA	1152x864	67.5	75Hz	108
	1280x960	60	60Hz	108
	1280x1024	63.981	60Hz	108
	1280x1024	79.976	75Hz	135
WXGA+	1440x900	55.935	60Hz	106.5
	1440x900	70.635	75Hz	136.75
WSXGA+	1680x1050	65.29	60Hz	146.25

IBM Modes

Mode	Resolution	H(KHz)	V(Hz)	Pixel(MHz)
DOS	640x350	31.469	70Hz	25.175
DOS	720x400	31.469	70Hz	28.322

MAC Modes

Mode	Resolution	H(KHz)	V(Hz)	Pixel(MHz)
VGA	640x480	35	67Hz	30.24
SVGA	832x624	49.725	75Hz	57.2832

VESA Modes

Mode	Resolution	H(KHz)	V(Hz)	Pixel(MHz)
720P	1280x720	44.772	60Hz	74.5
	1280x720	56.456	75Hz	95.75
WXGA+	1280x768	47.776	60Hz	79.5
	1280x768	60.289	75Hz	102.25
	1280x800	49.702	60Hz	83.5
	1280x800	62.795	75Hz	106.5
1080P	1920x1080	66.587	60Hz	138.5
WUXGA	1920x1200	74.038	60Hz	154

4.4 Panel Specification

4.4.1 General Features

TPM220Z1-PS3 IS A 22" WIDE TFT LIQUID CRYSTAL DISPLAY MODULE WITH 4 CCFL BACKLIGHT UNIT AND 55PIN RSDS INTERFACE. THIS MODULE SUPPORTS 1680 X 1050 WSXGA+ MODE AND CAN DISPLAY 16.7 M COLORS.

- Super Wide viewing angle.
- Super High contrast ratio
- Super fast response time
- High color saturation
- WSXGA+ (1680 x 1050 pixels) resolution
- RSDS (reduced swing differential signaling) interface
- RoHS Compliance

4.4.2 Display Characteristics

Item	Specification	Unit
Diagonal Size	22" wide diagonal	mm
Active Area	473.76 (H) x 296.1 (V)	mm
Bezel Opening Area	477.7x 300.1	mm
Driver Element	a-si TFT active matrix	-
Pixel Number	1680 x R.G.B. x 1050	pixel
Pixel Pitch	0.282 (H) x 0.282 (V)	mm
Pixel Arrangement	RGB vertical stripe	-
Display Colors	16.7M	color
Transmissive Mode	Normally White	-
Surface Treatment	Hard coating (3H)	-

4.4.3 Electrical Characteristics

(1) TFT-LCD

Parameter	Symbol	Value			Unit
		Min.	Typ.	Max.	
Power Supply Voltage	V _{CC}	4.5	5.0	5.5	V
Ripple Voltage	V _{RP}	-	-	100	mV
Rush Current	I _{RUSH}	-	-	3	A
Power Supply Current	White	-	-	0.728	A
	Black	-	-	1.078	A
	Vertical Stripe	-	-	1.078	A
LVDS differential input voltage	V _{id}	100	-	600	mV
LVDS common input voltage	V _{ic}	-	1.2	-	V

(2) Backlight

Parameter	SYMBOL	Value			UNIT
		MIN	TYP	MAX	
Power Supply Voltage for LCD	Vcc	4.5	5	5.7	V
Differential Impedance	Zm		100		Ω
LCD Inrush Current	Irush		3		A
Power Consumption	P		6.6		W
VCOM PWM	High	VCOM_PWM	2.5		V
	Low				
VCOM PWM Frequency	VCOM_PWM	27		KHz	Adjustable Duty Cycle

4.4.4 Optical Characteristics

Item		Symbol	Condition	Min.	Typ.	Max.	Unit				
Color Chromaticity	Red	Rcx	$\theta_x=0^\circ, \theta_y=0^\circ$ Standard light source "C"	Typ - 0.03	0.649	Typ + 0.03	-				
		Rcy			0.335		-				
	Green	Gcx			0.283		-				
		Gcy			0.605		-				
	Blue	Bcx			0.151		-				
		Bcy			0.073		-				
	White	Wcx			0.313		-				
		Wcy			0.329		-				
	Contrast Ratio				CR			700	1000	---	----
	Response Time				T_R		$\theta_x=0^\circ, \theta_y=0^\circ$	---	1.3	2.2	ms
T_F			---	3.7	5.8	ms					
White Variation		δW	$\theta_x=0^\circ, \theta_y=0^\circ$	---	1.1	---	-				
Viewing Angle	Horizontal	θ_{x+}	CR \geq 10	75	85	---	Deg.				
		θ_{x-}		75	85	---					
	Vertical	θ_{y+}		70	80	---					
		θ_{y-}		70	80	---					

5. Block Diagram

5.1 Software Flow Chat

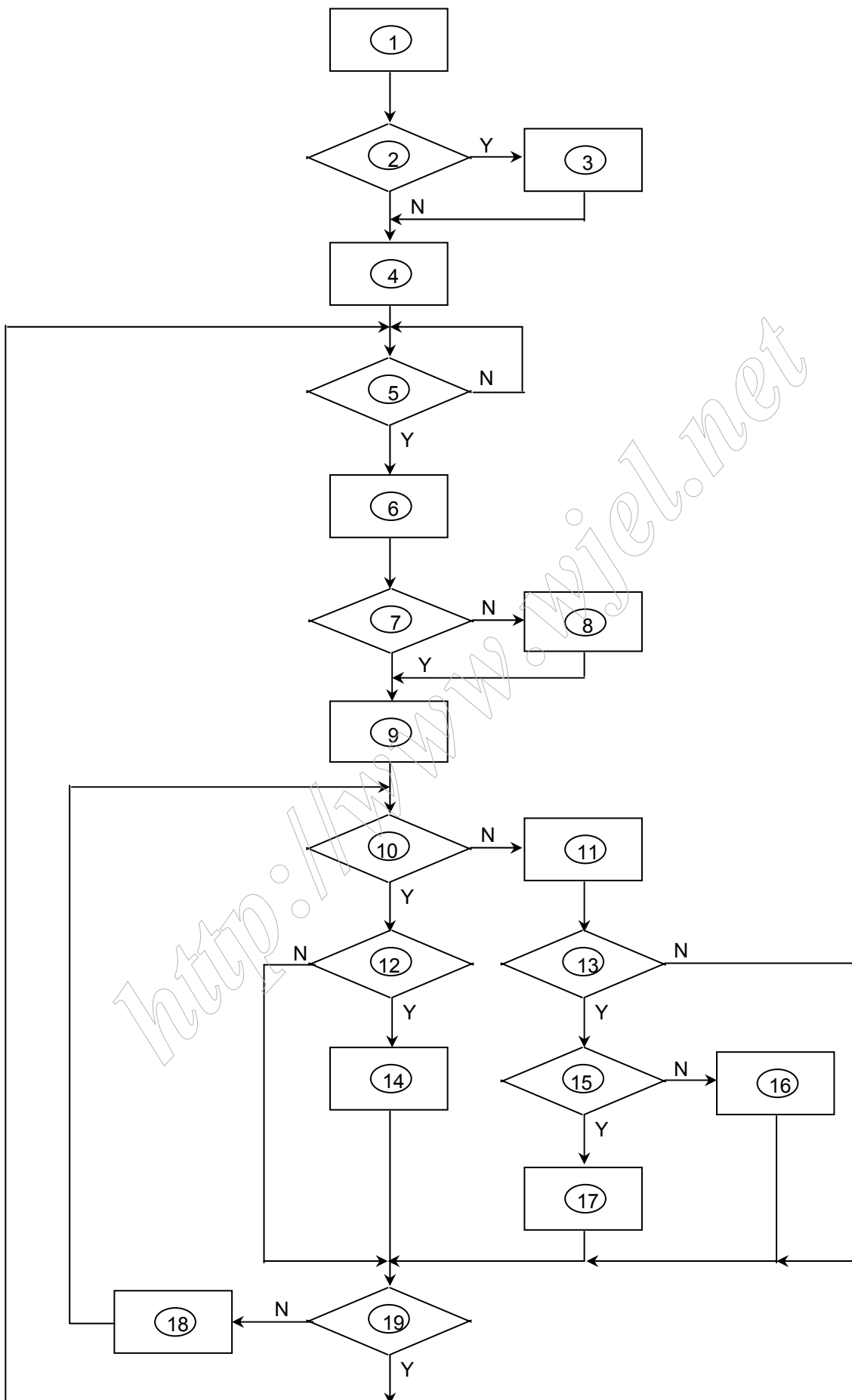

1) MCU initialize.
2) Is the EPROM blank?
3) Program the EPROM by default values.
4) Get the PWM value of brightness from EPROM.
5) Is the power key pressed?
6) Clear all global flags.
7) Are the AUTO and SELECT keys pressed?
8) Enter factory mode.
9) Save the power key status into EPROM. Turn on the LED and set it to green color. Scalar initializes.
10) In standby mode?
11) Update the lifetime of back light.
12) Check the analog port, are there any signals coming?
13) Does the scalar send out an interrupt request?
14) Wake up the scalar.
15) Are there any signals coming from analog port?
16) Display "No connection Check Signal Cable" message. And go into standby mode after the message disappear.
17) Program the scalar to be able to show the coming mode.
18) Process the OSD display.
19) Read the keyboard. Is the power key pressed?

5.2 Electrical Block Diagram

5.2.1 Main Board

for VK222U

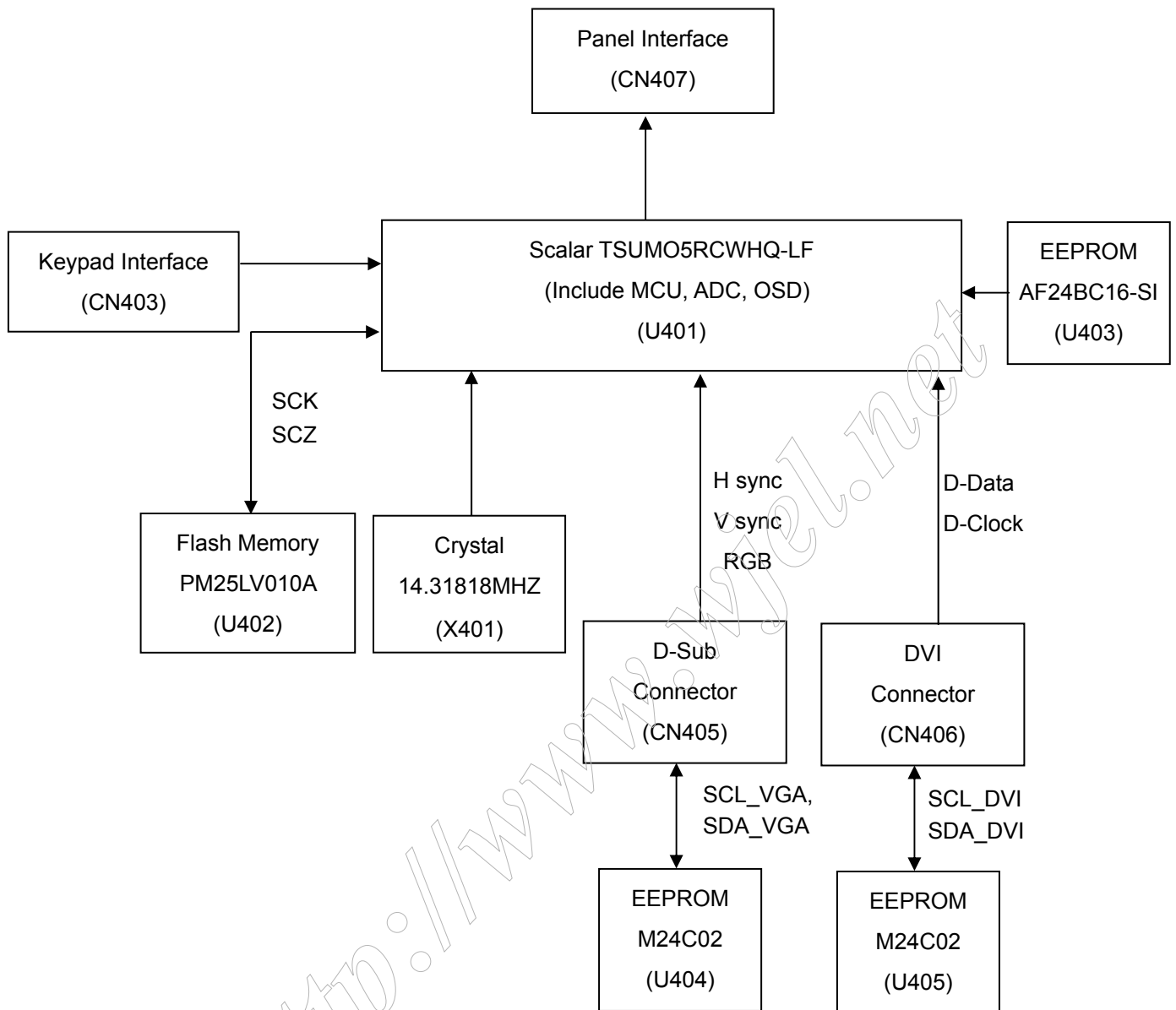

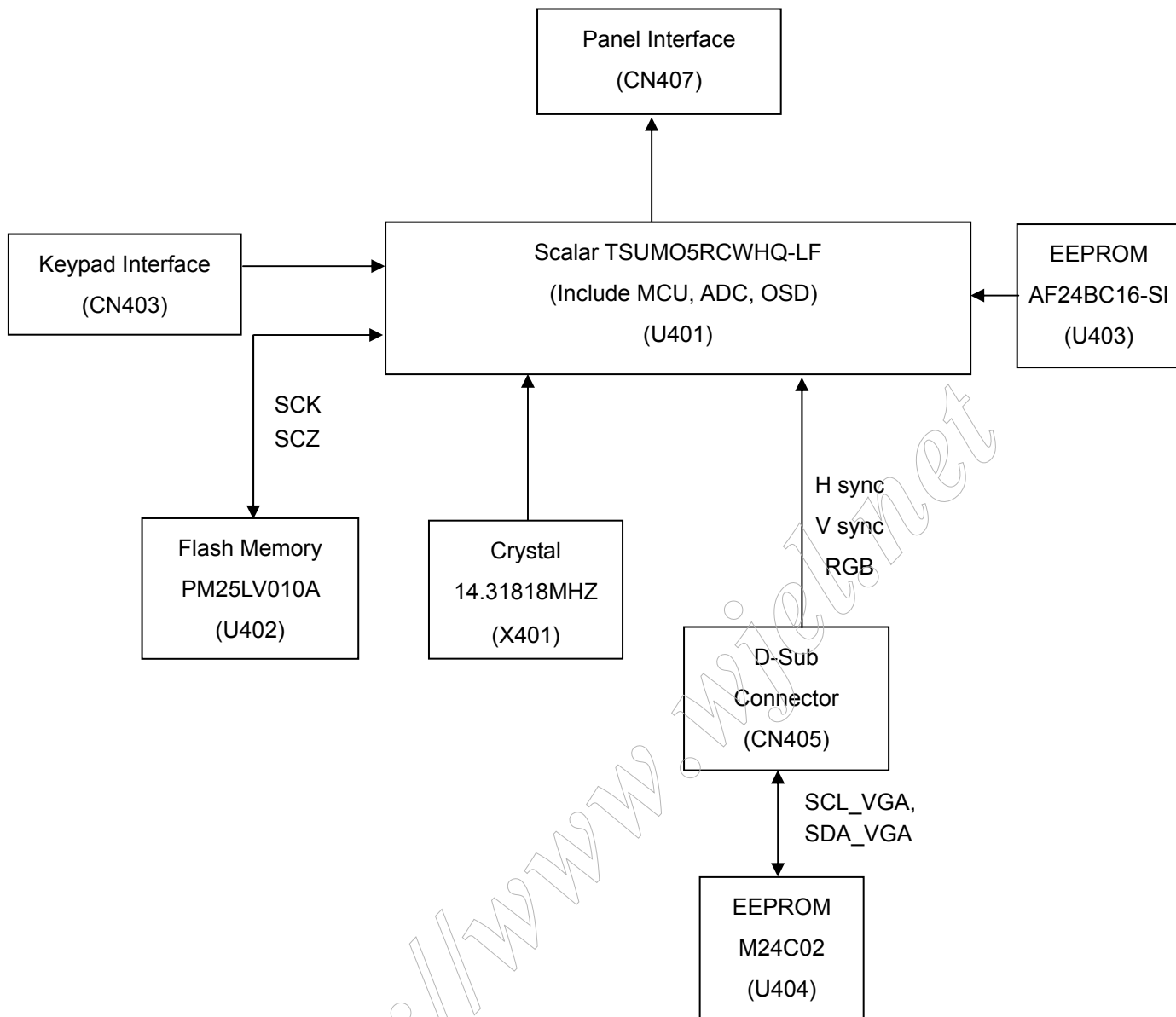

5.2.2 Inverter/Power Board

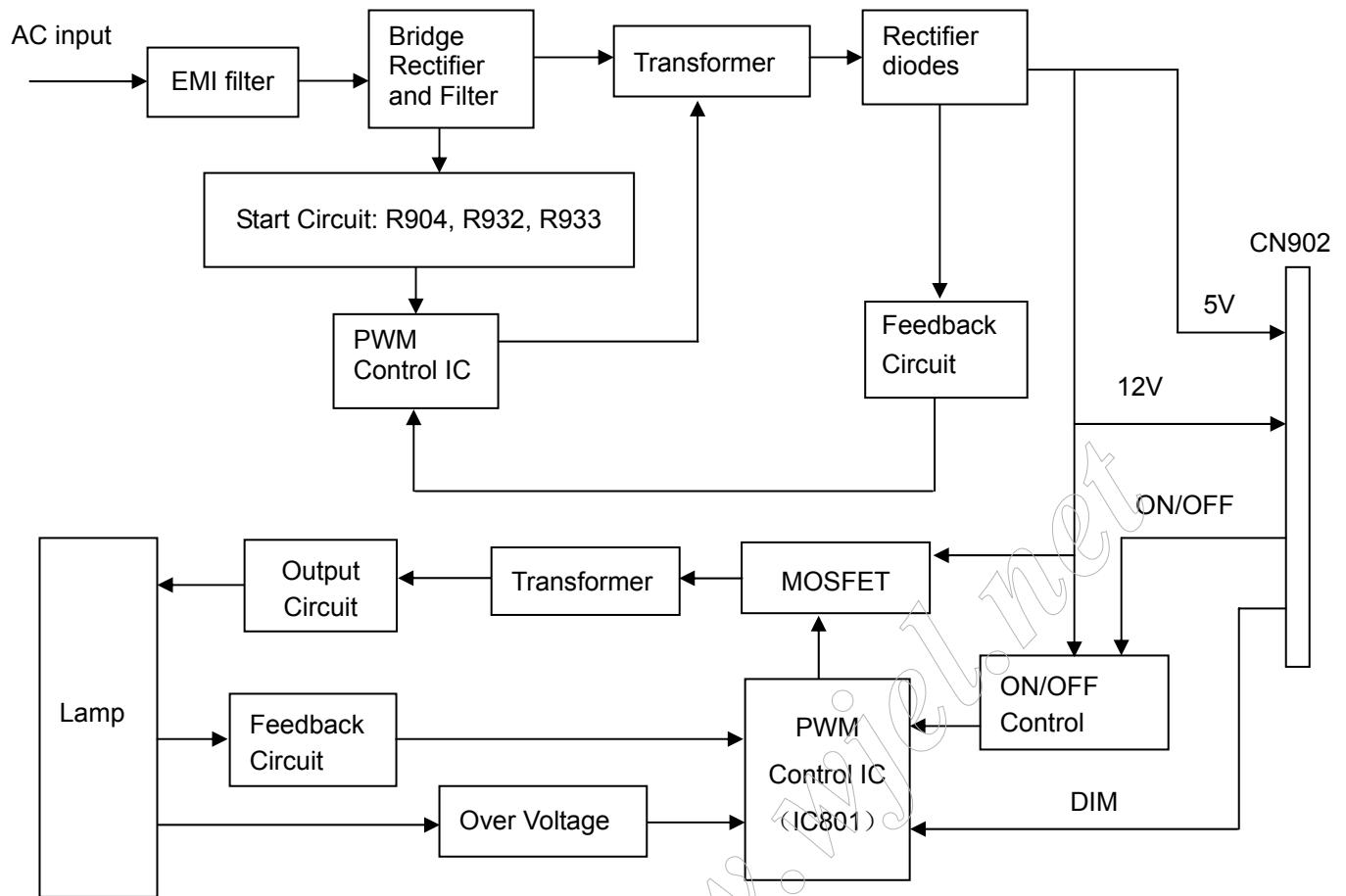

<http://www.asus.com>

6. Schematic

6.1 Main Board

715G2670-1-2

TSUMO5RCWHQ SCHEMATIC

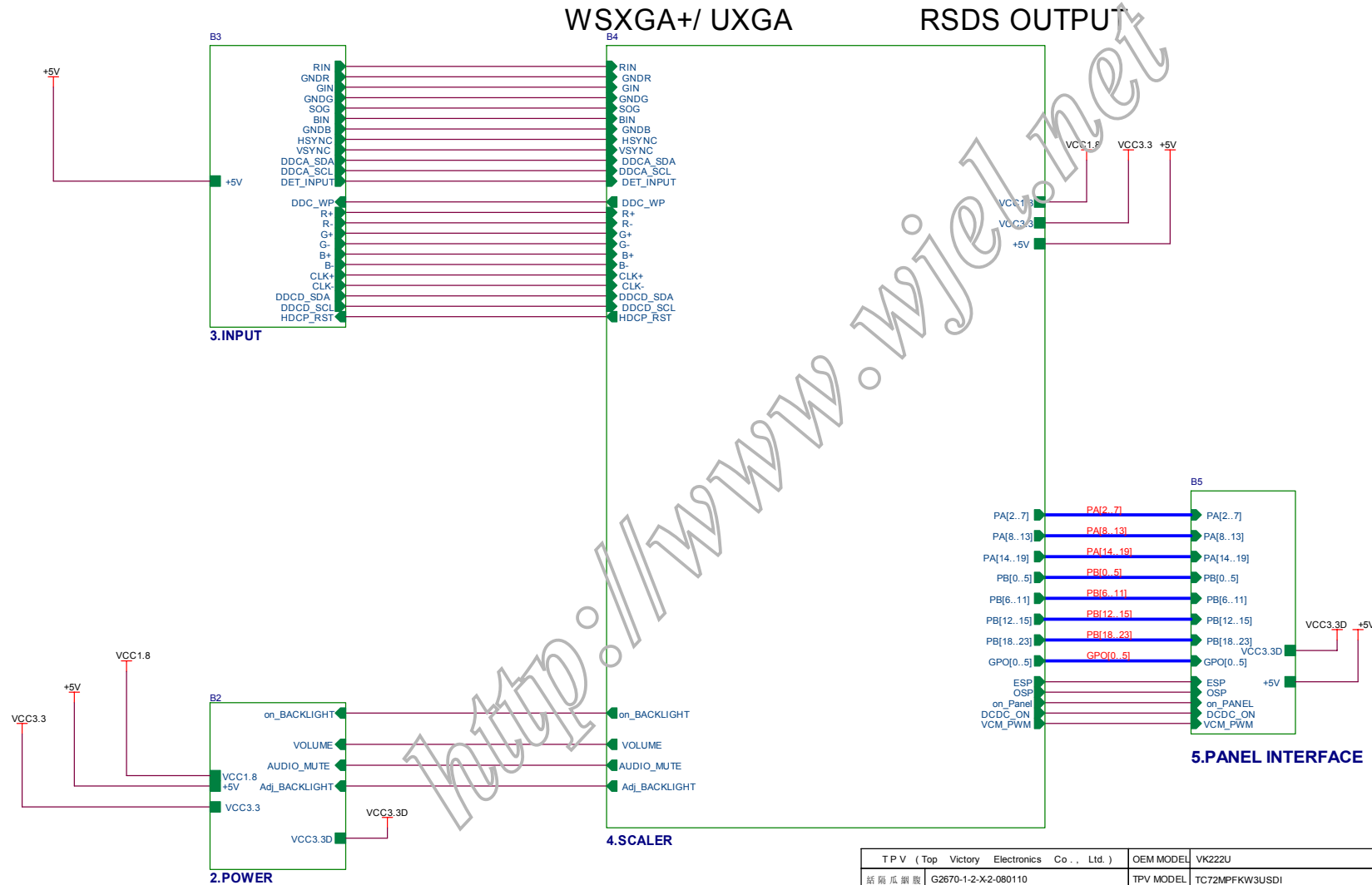

TPV (Top Victory Electronics Co., Ltd.)	OEM MODEL	VK222U	Size	B
基爾瓜爾廠	G2670-1-2-X2-080110	TPV MODEL	TC72MPFKW3USD1	Rev 1
Key Component	1.2 TOP	PCB NAME	715G2670-1-2	稱號 <稱號>
Date	Thursday, January 10, 2008	Sheet	1.2 of 5	

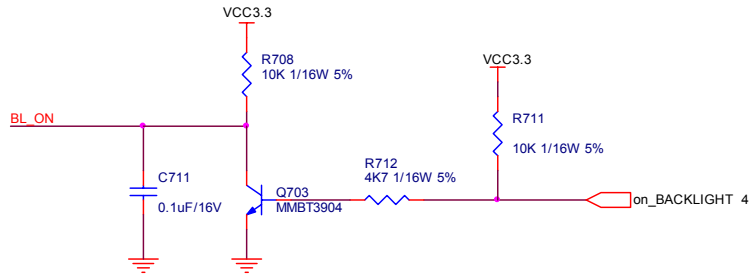
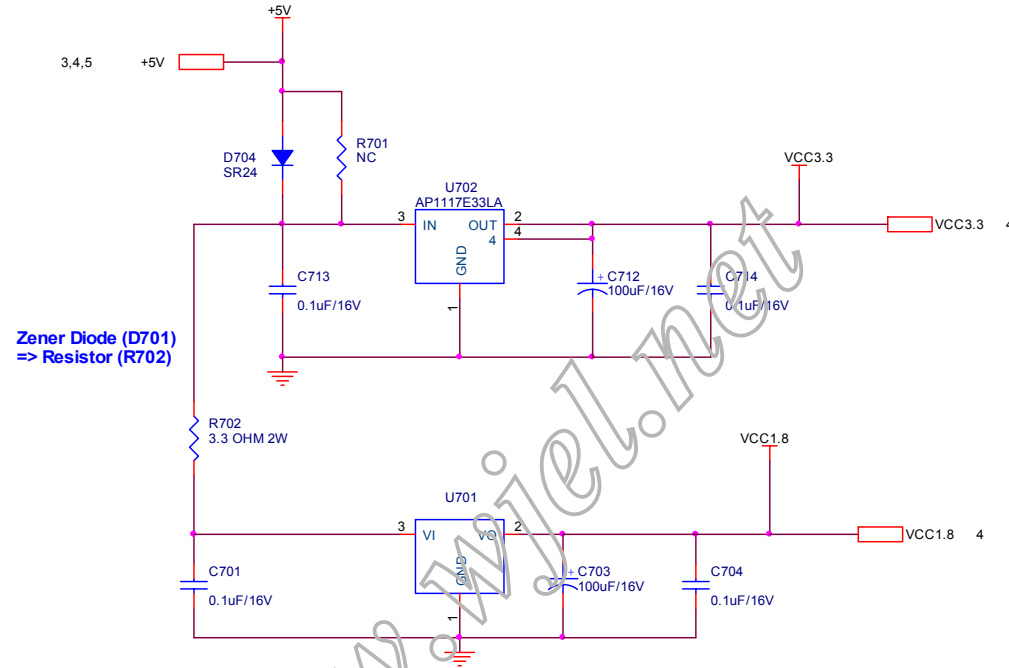
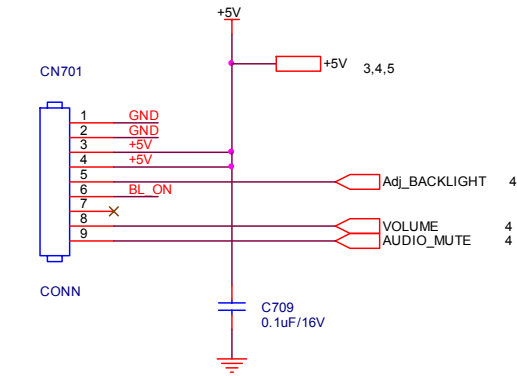

http://www.wiel.net

TPV (Top Victory Electronics Co., Ltd.)	OEM MODEL	VK222U	Size	B
结构瓜 網膜	G2670-1-2-X-2-080110	TPV MODEL	TC72MPFKW3USDI	Rev
Key Component	2. POWER	PCB NAME	715G2670-1-2	称差
Date	Thursday, January 10, 2008	Sheet	2 of 5	<称差>

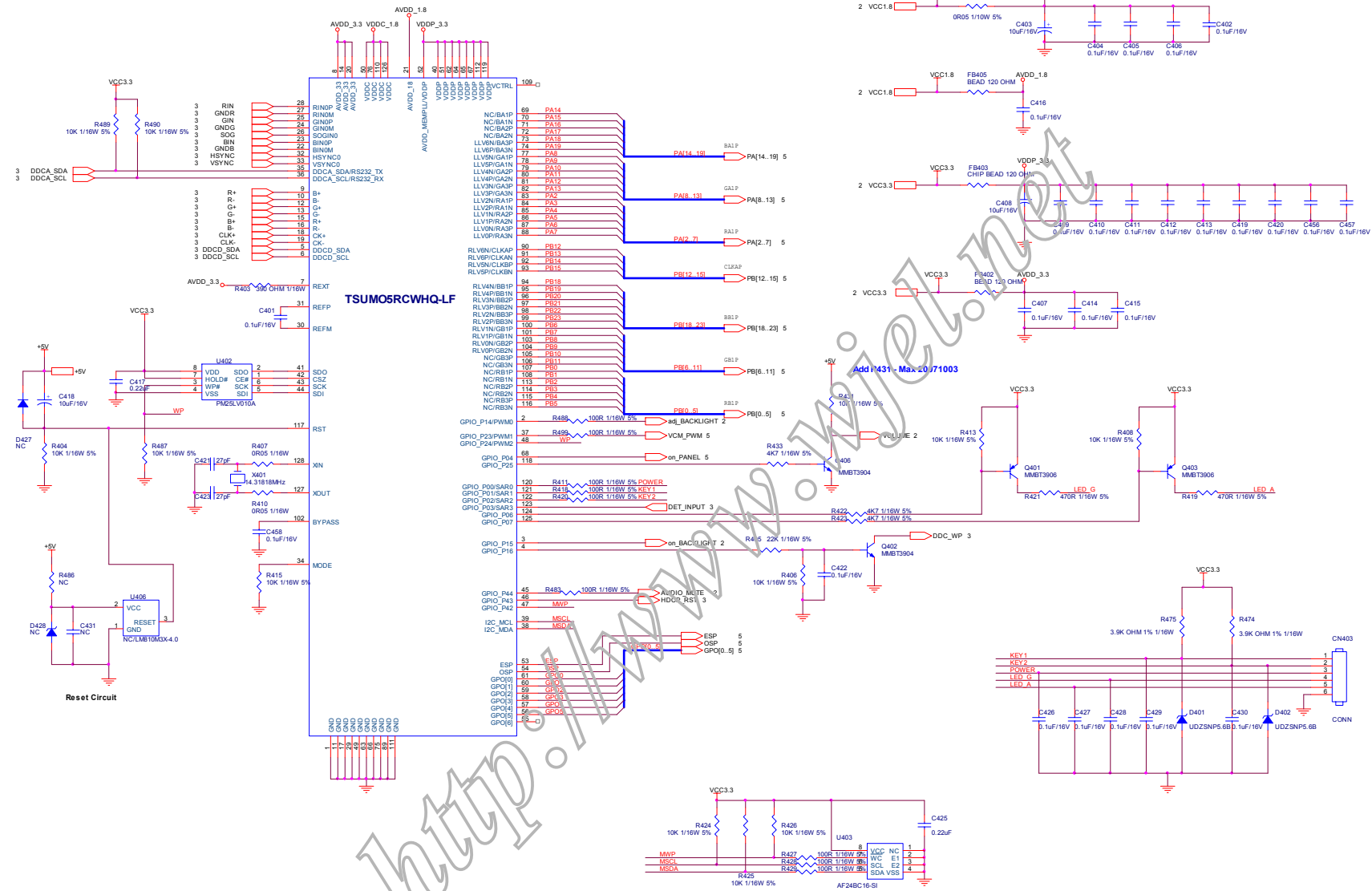

TP V (Top Victory Electronics Co., Ltd.)	OEM MODEL VK22U	Size C
產品代號 G2670-1.2-X2-080110	TPV MODEL TC72MPPFW3USDI	Rev 1
Key Comment A_SCALDR	PCB NAME 715G2670-1.2	File <R>
Date Thursday, January 10, 2008	Sheet 4 of 5	

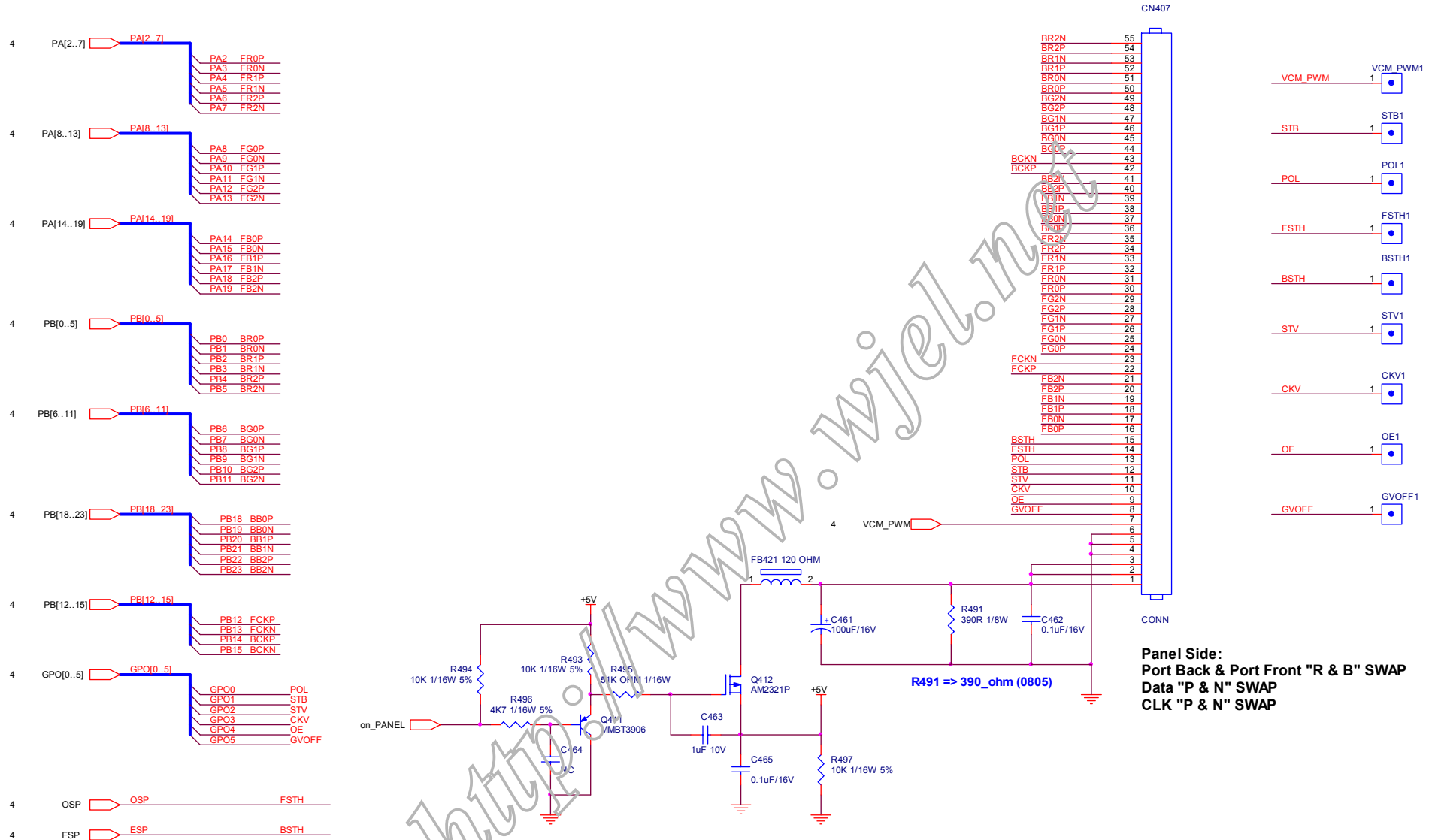

TPV (Top Victory Electronics Co., Ltd.)	OEM MODEL	VK222U	Size	B
銘稱瓜爾	G2670-1-2-X2-080110	TPV MODEL	TC72MPFKW3USD1	Rev
Key Component	5. PANEL INTERFACE	PCB NAME	715G2670-1-2	稱號
Date	Thursday, January 10, 2008	Sheet	5 of 5	<稱號>

6.2 Power Board

715G2538-4

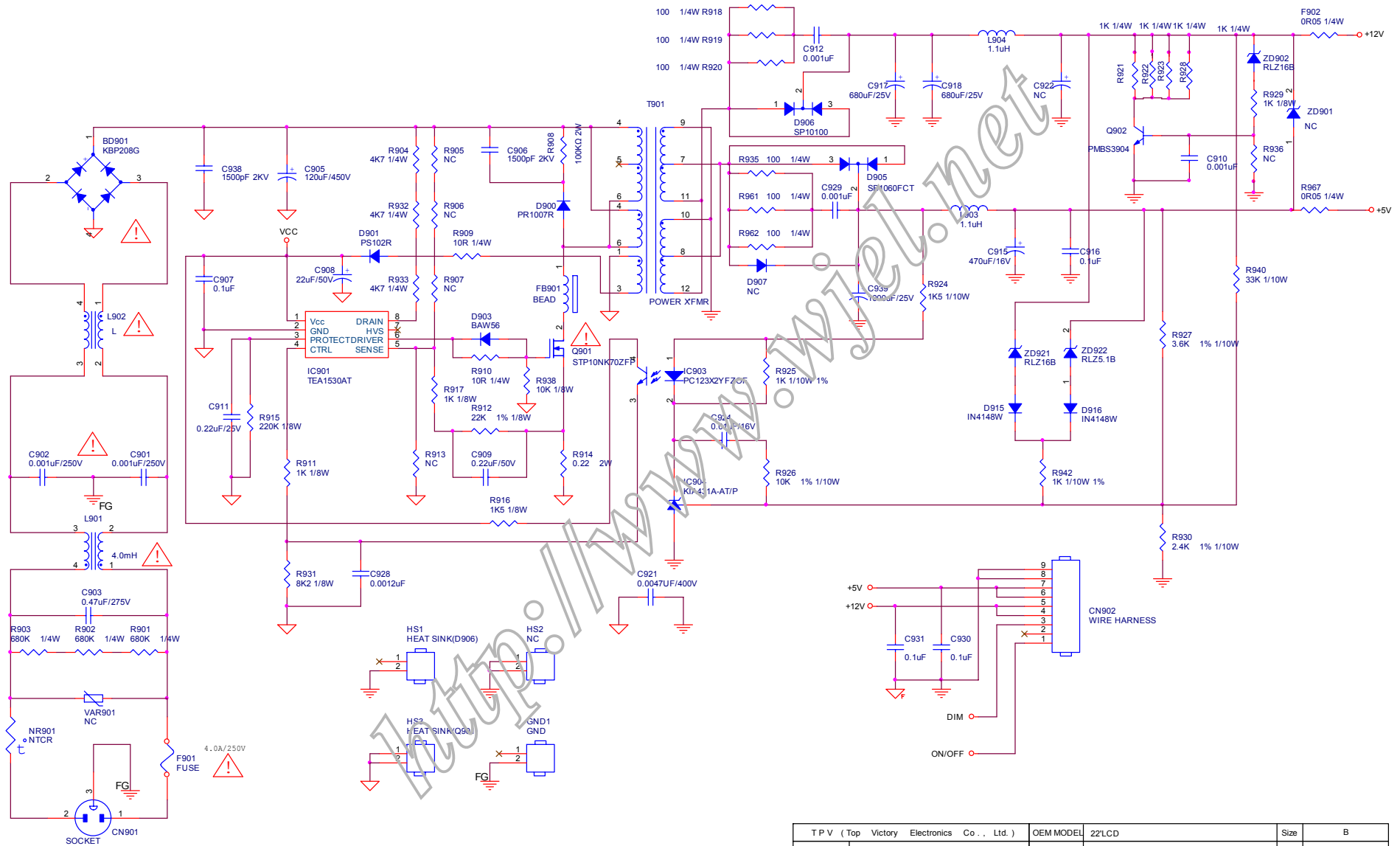

TPV (Top Victory Electronics Co., Ltd.)	OEM MODEL	22"LCD	Size	B
話隔瓜徽	G2538-3-XX-21-071207	TPV MODEL	PWPC7C42CQD3	Rev
Key Component	02.POWER	PCB NAME	715G2538 4	Rev
Date	Friday, December 07, 2007	Sheet	2 of 3	<修>

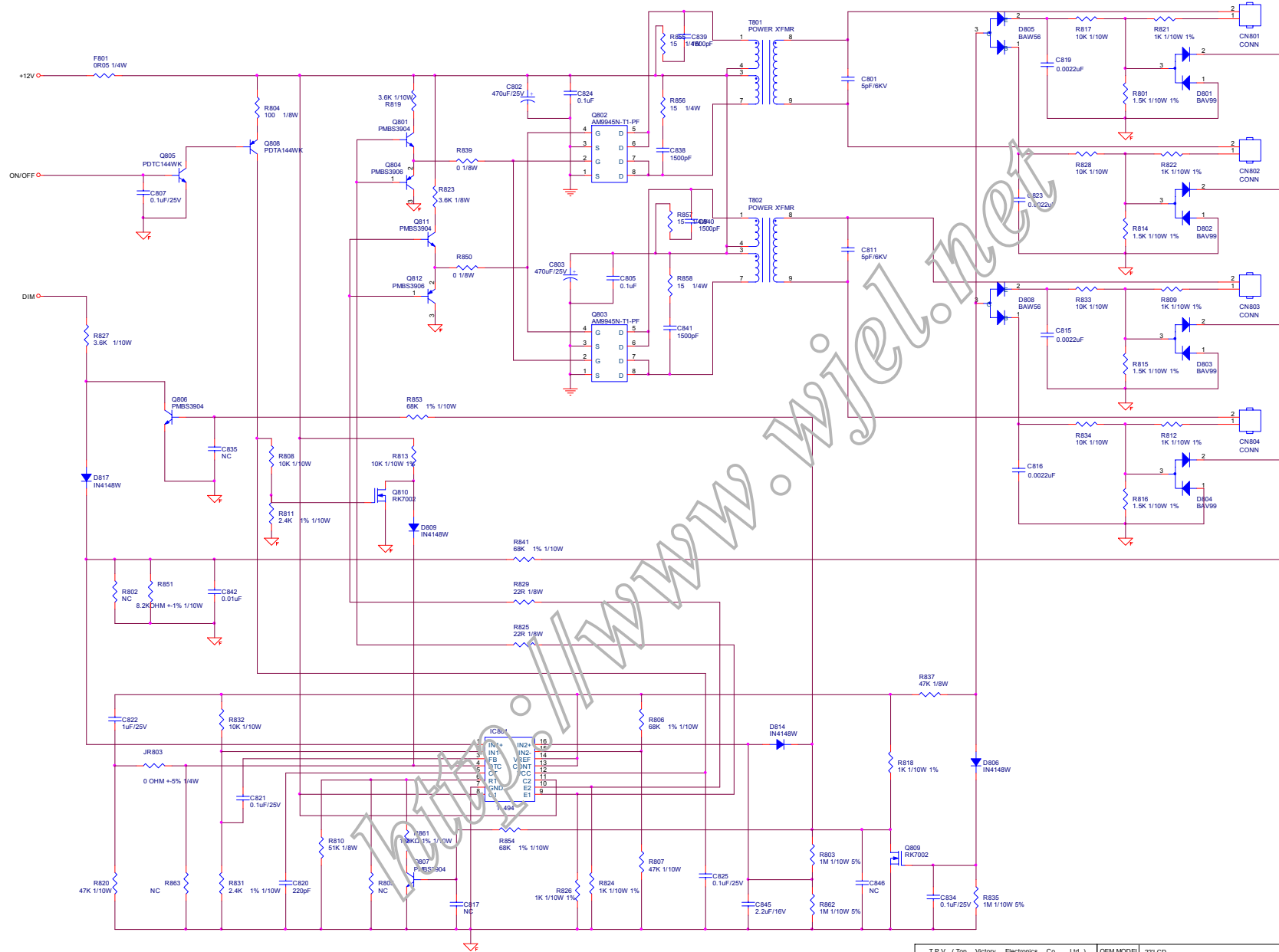

T P V (Top Victory Electronics Co., Ltd.)	OEM MODEL	Z2LCD	Size	Custom
註 冊 商 標	G2538-3-X-X21-071207	TPV MODEL	PWPCTC42CQD3	Rev
Key Component	03 INVERTER	PCB NAME	715G2538_3	1
Date	Friday, December 07, 2007	Sheet	3 of 3	<非>

6.3 Audio Board

715G2767-1

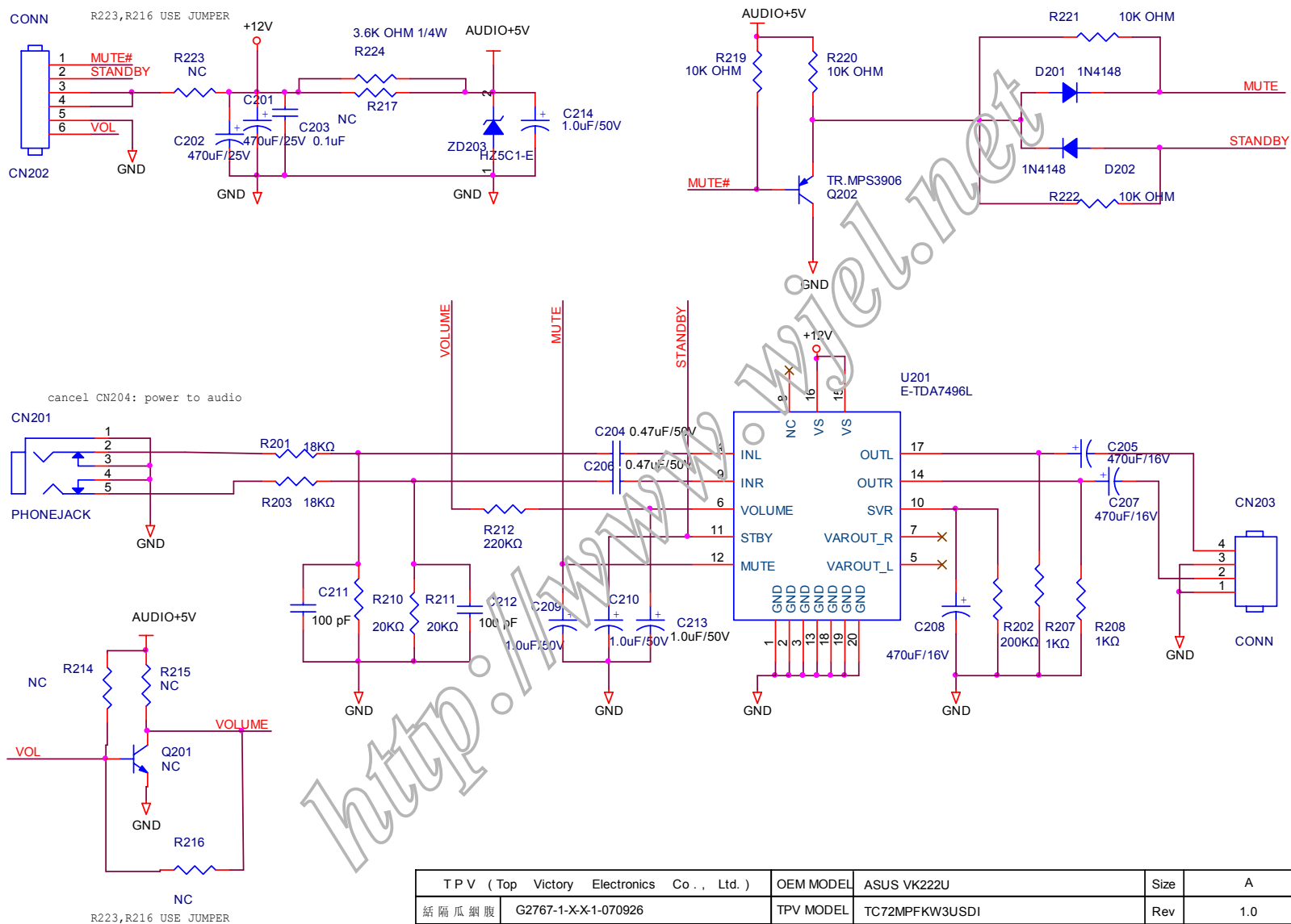

TPV (Top Victory Electronics Co., Ltd.)	OEM MODEL	ASUS VK222U	Size	A	
結構瓜網版	G2767-1-X-X-1-070926	TPV MODEL	TC72MPFKW3USDI	Rev	1.0
Key Component	02.AUDIO BOARD	PCB NAME	715G2767-1	稱號	<稱號>
Date	Wednesday, September 26, 2007	Sheet	2 of 2		

7. PCB Layout

7.1 Main Board

715G2670-1-2

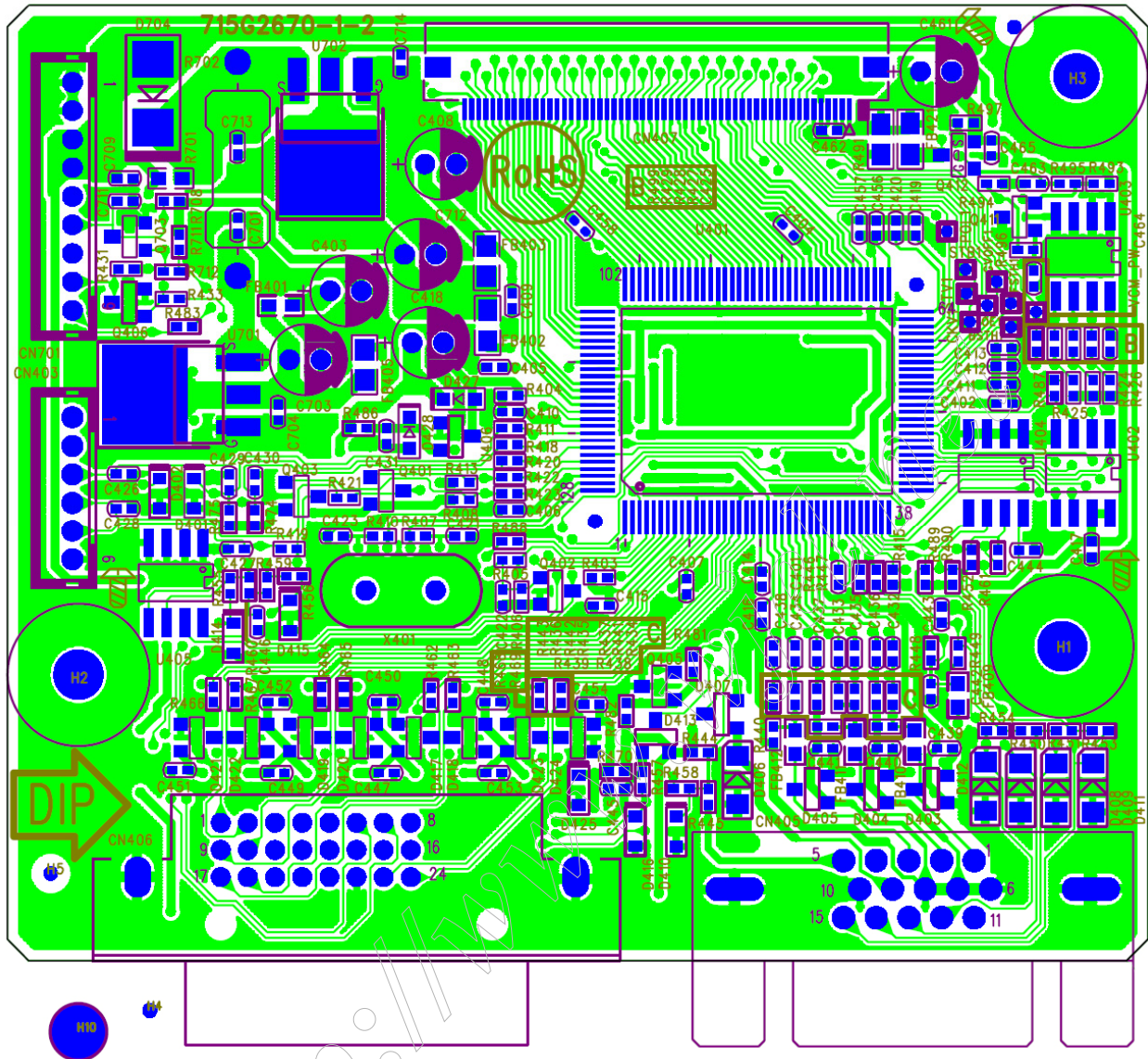

7.2 Power Board

715G2538-4

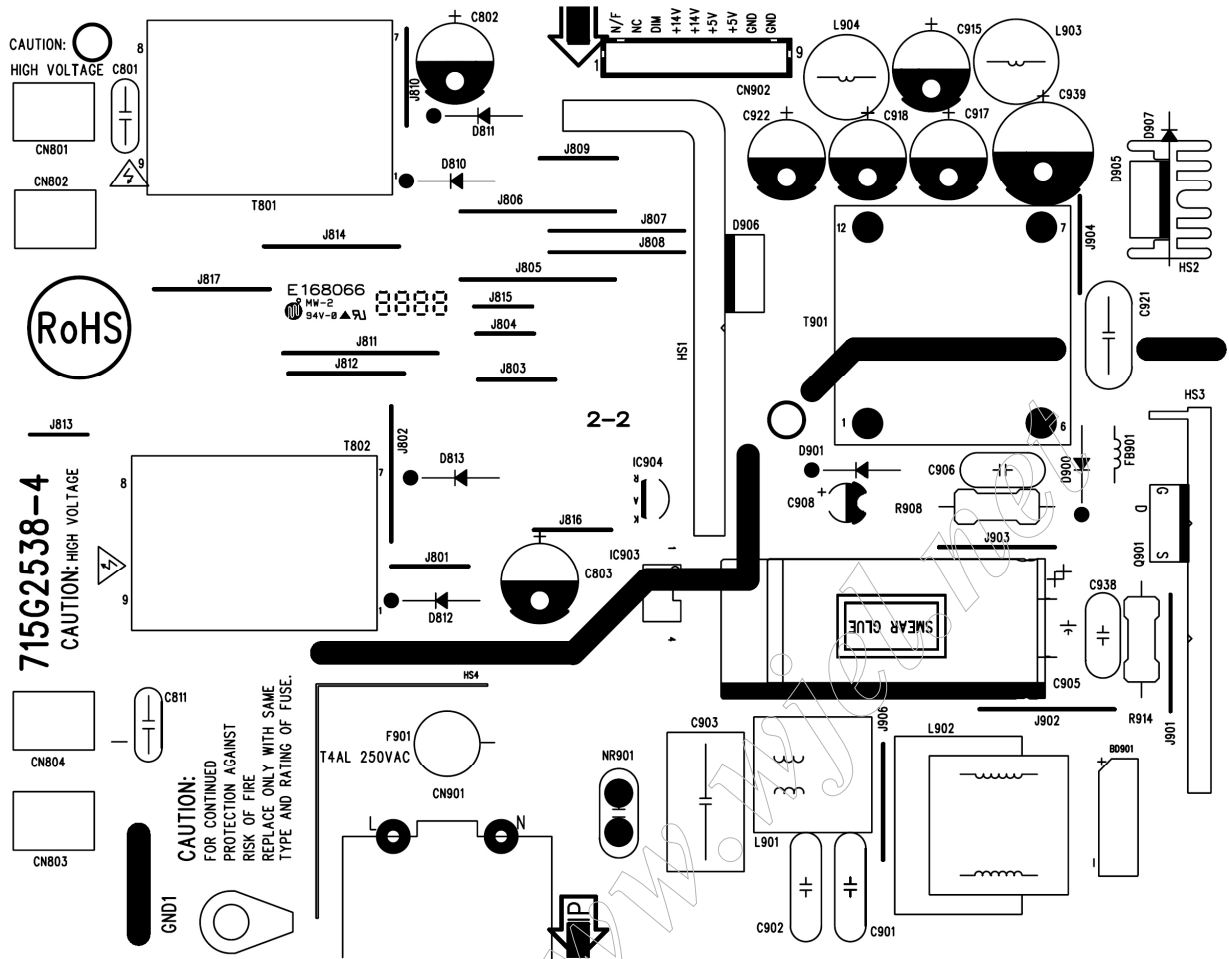

<http://www.bios-downloads.com>

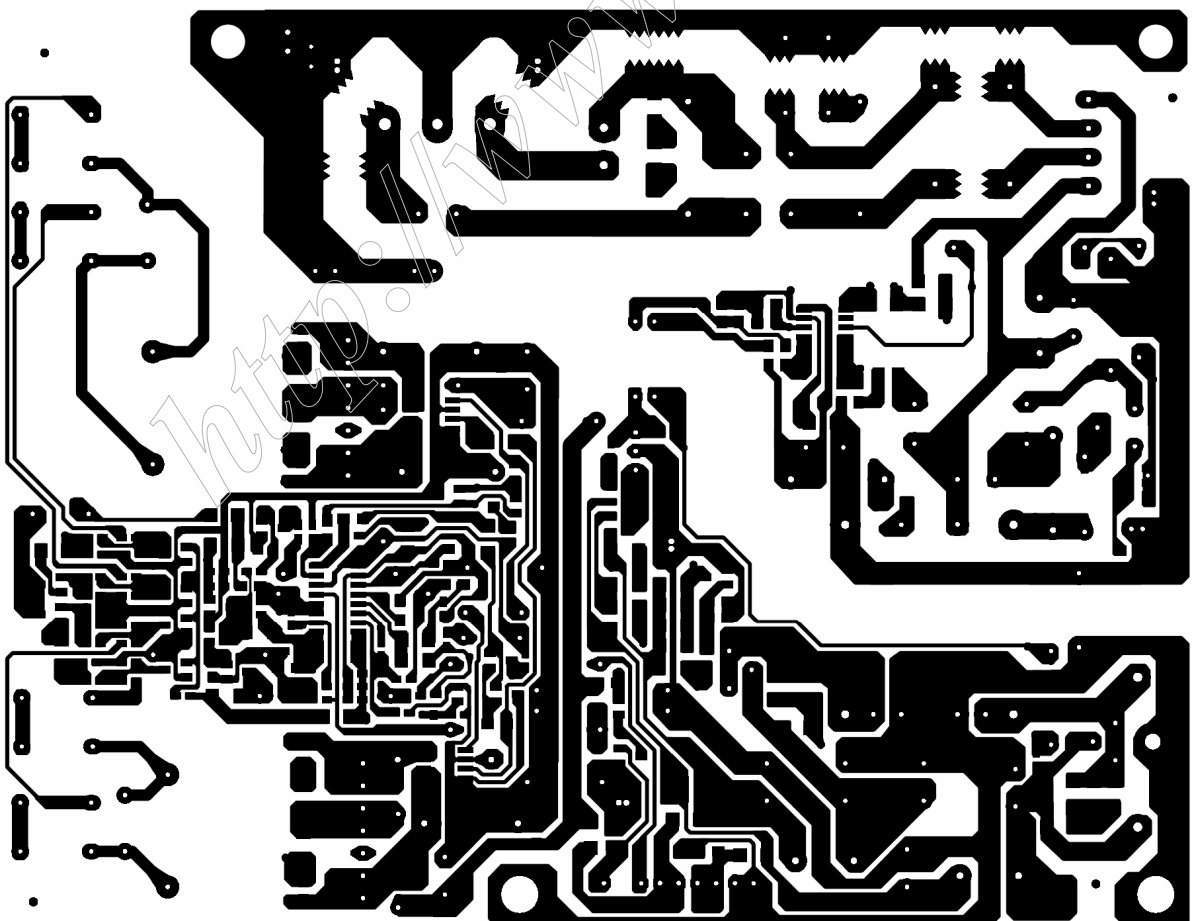
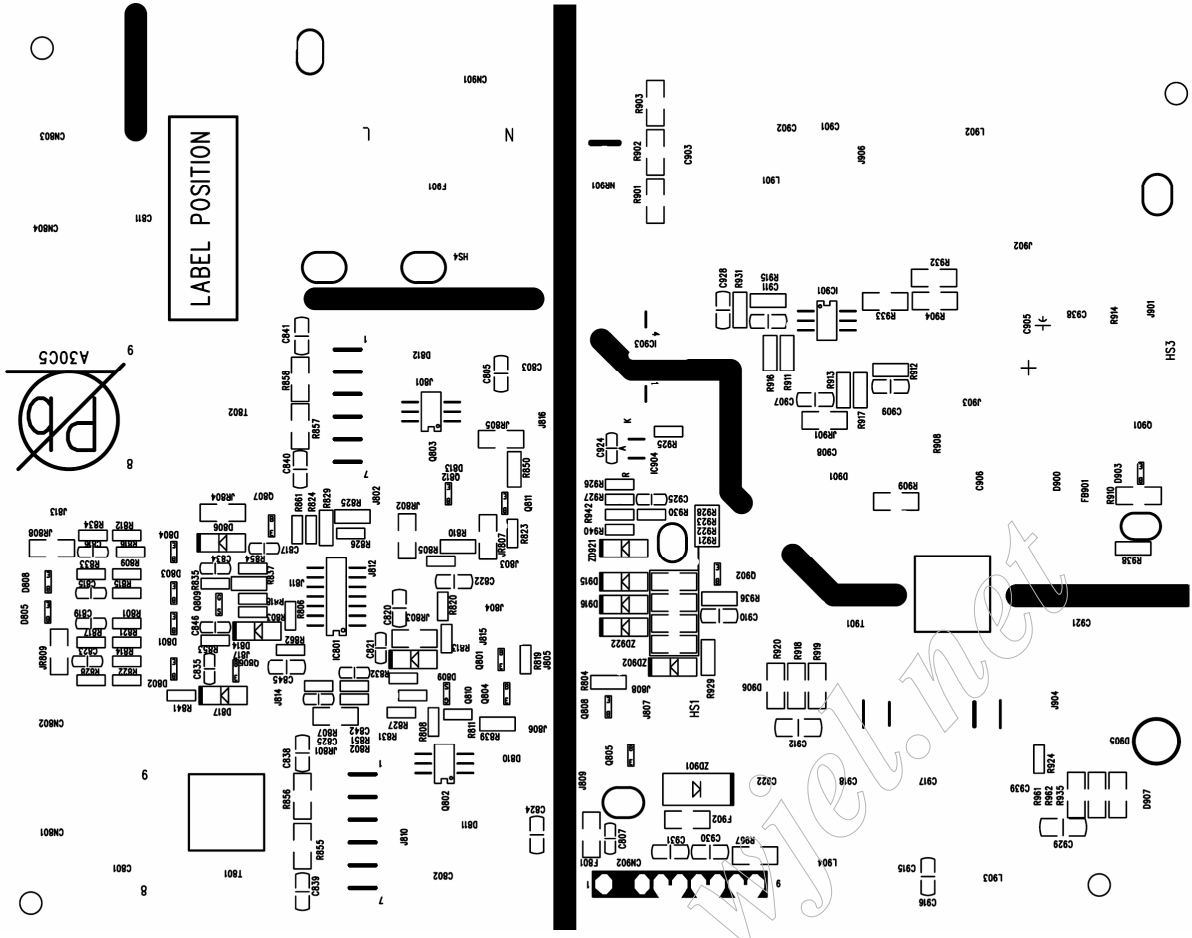

7.3 Audio Board

715G2767-1

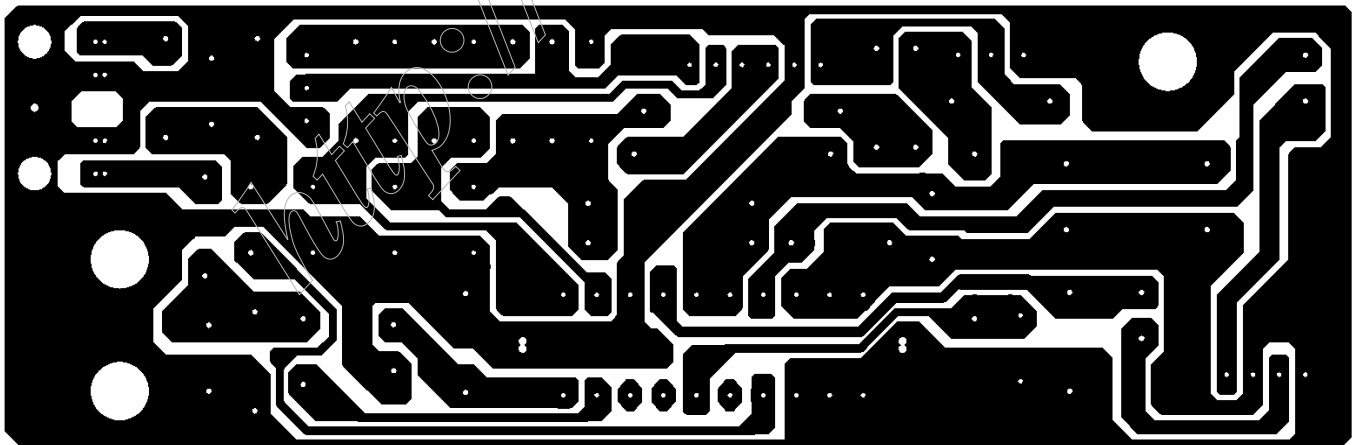
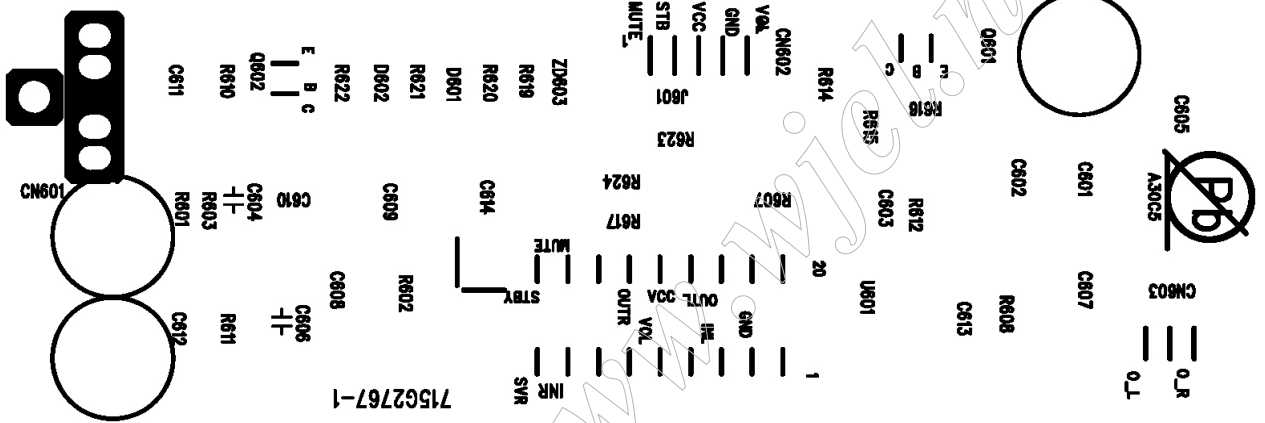
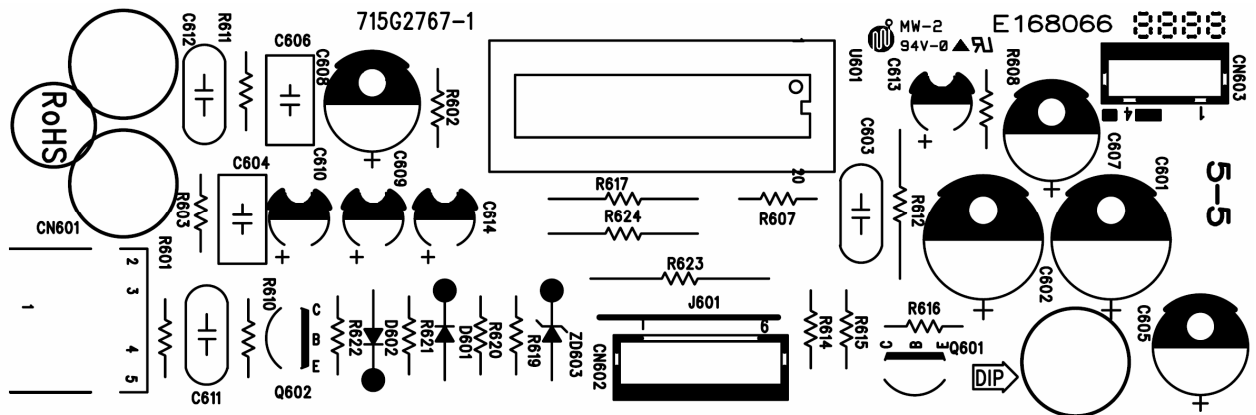

7.4 Key Board

715G2900-1

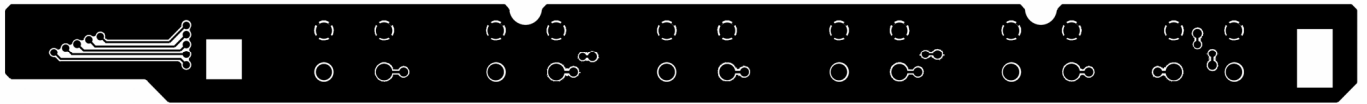

<http://www.wjnet.net>

8. Maintainability

8.1 Equipments and Tools Requirement

1. Voltmeter.
2. Oscilloscope.
3. Pattern Generator.
4. DDC Tool with an IBM Compatible Computer.
5. Alignment Tool.
6. LCD Color Analyzer.
7. Service Manual.
8. User Manual.

<http://www.wjel.net>

8.2 Trouble Shooting

8.2.1 Main Board

(1). No Power

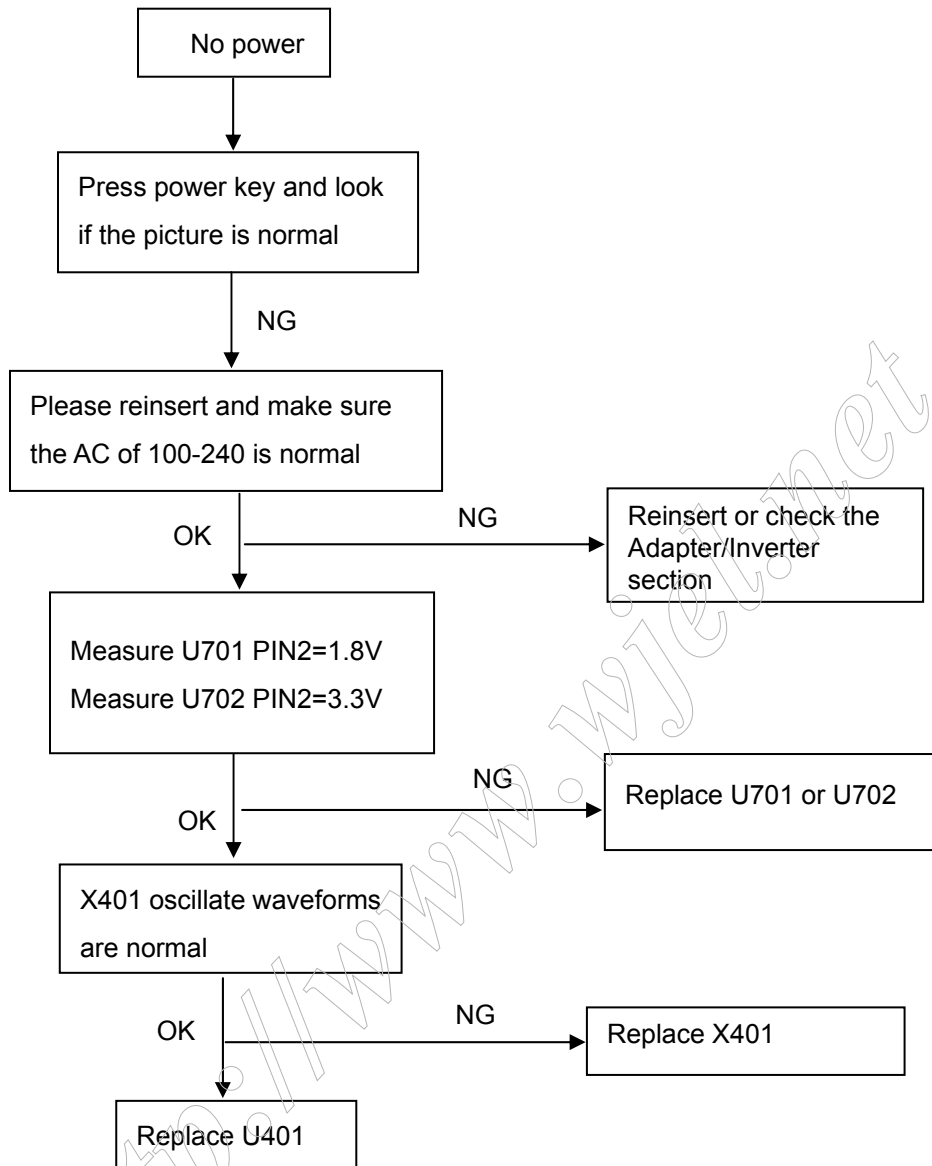

(2). No Picture

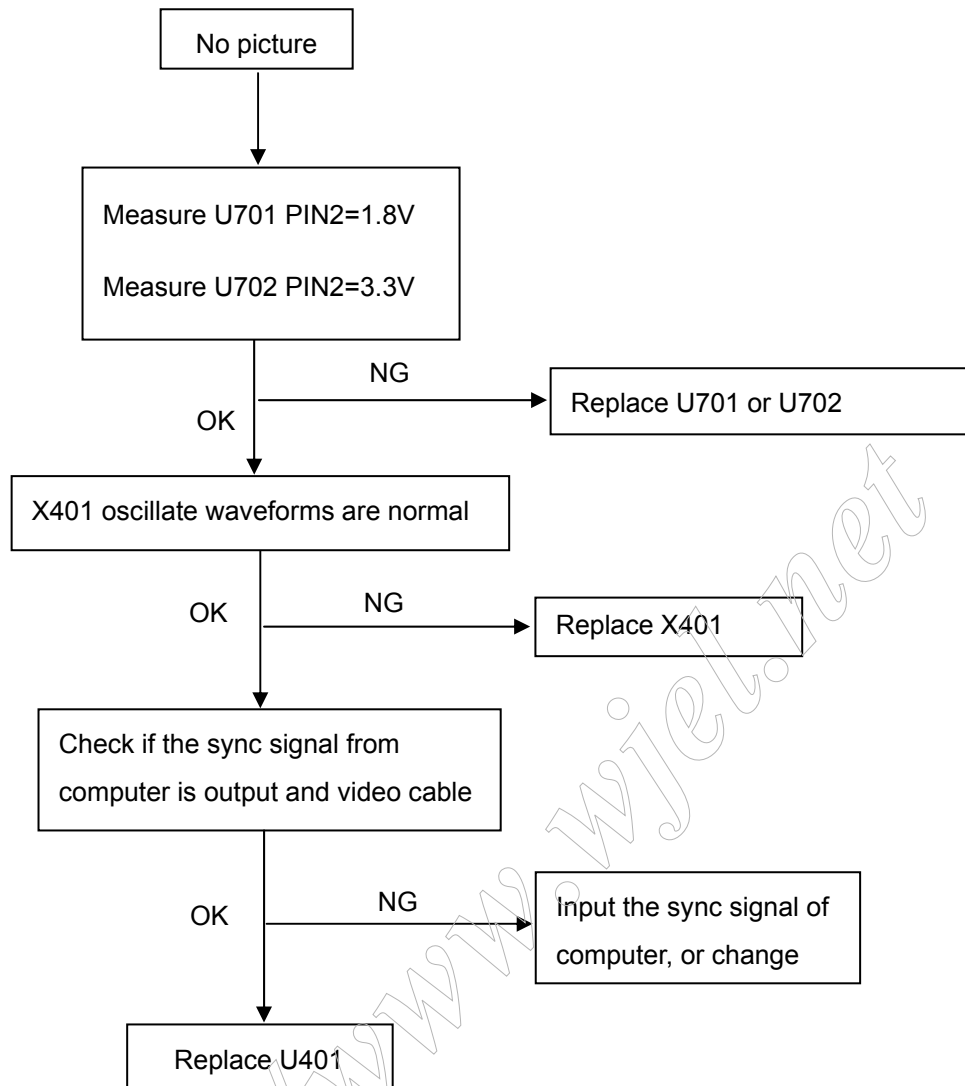

(3). White screen

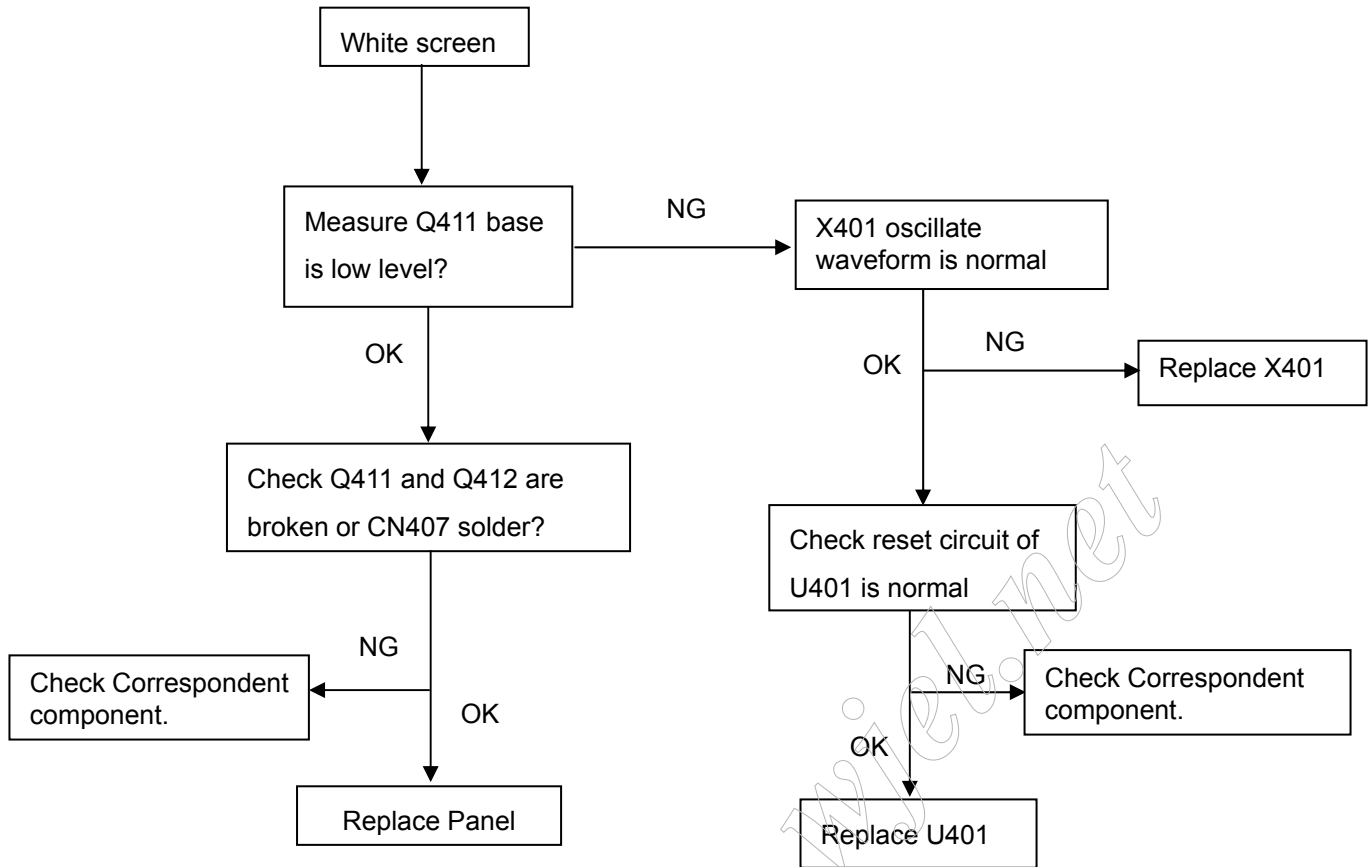

<http://www.tweakt.net>

8.2.2 Power/Inverter Board

1.) No power

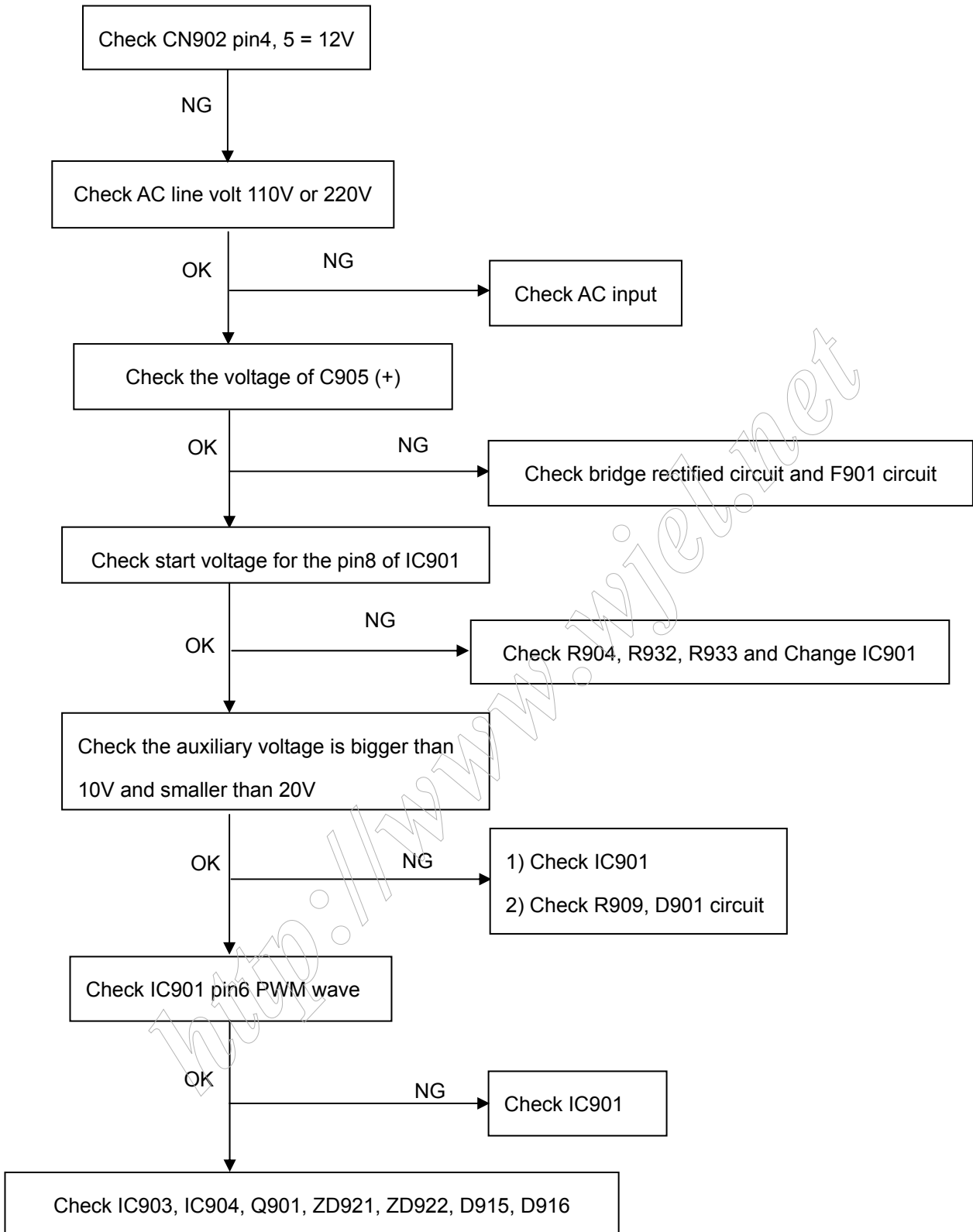

2.) W / LED, No Backlight

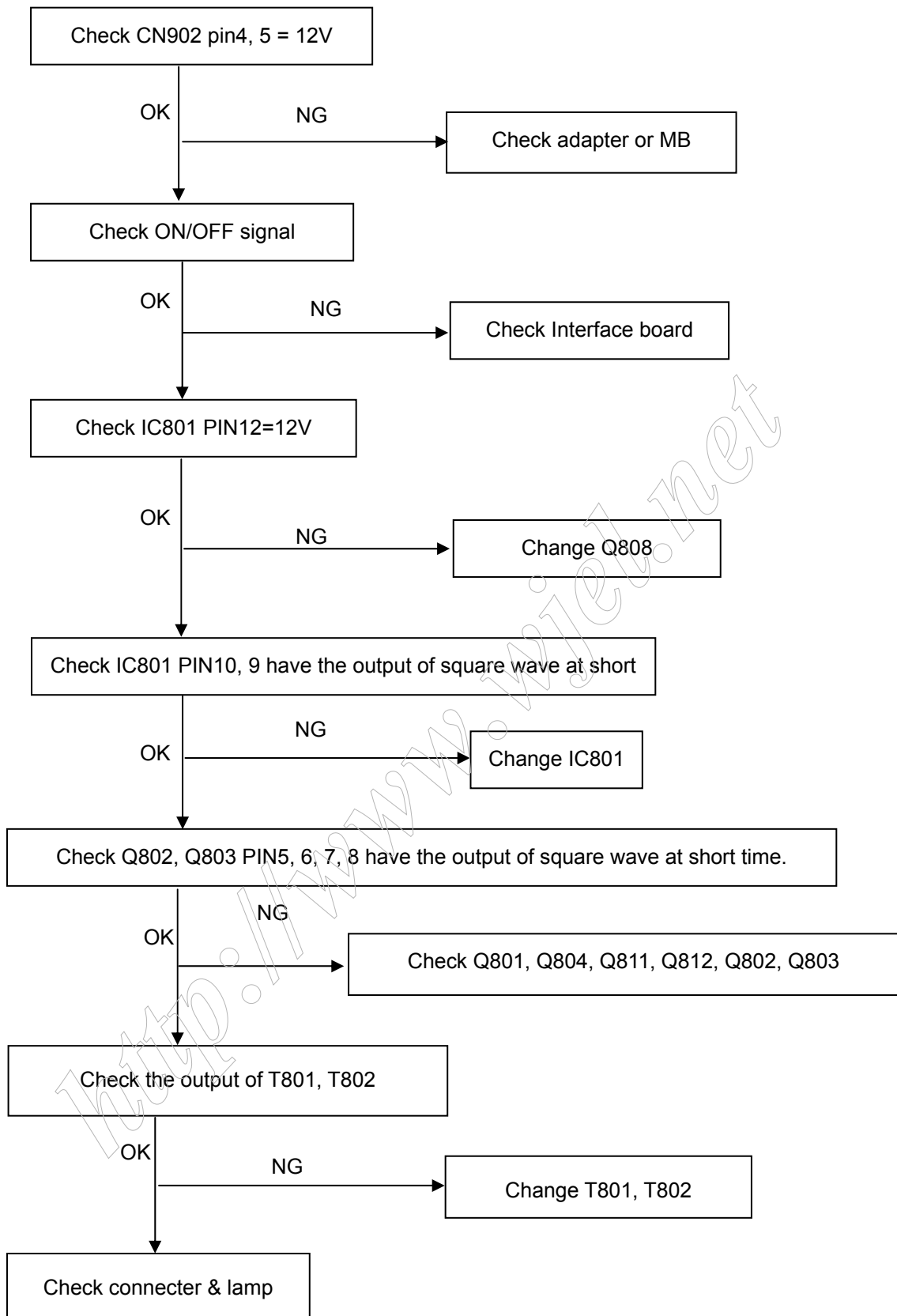

8.2.3 Key Board

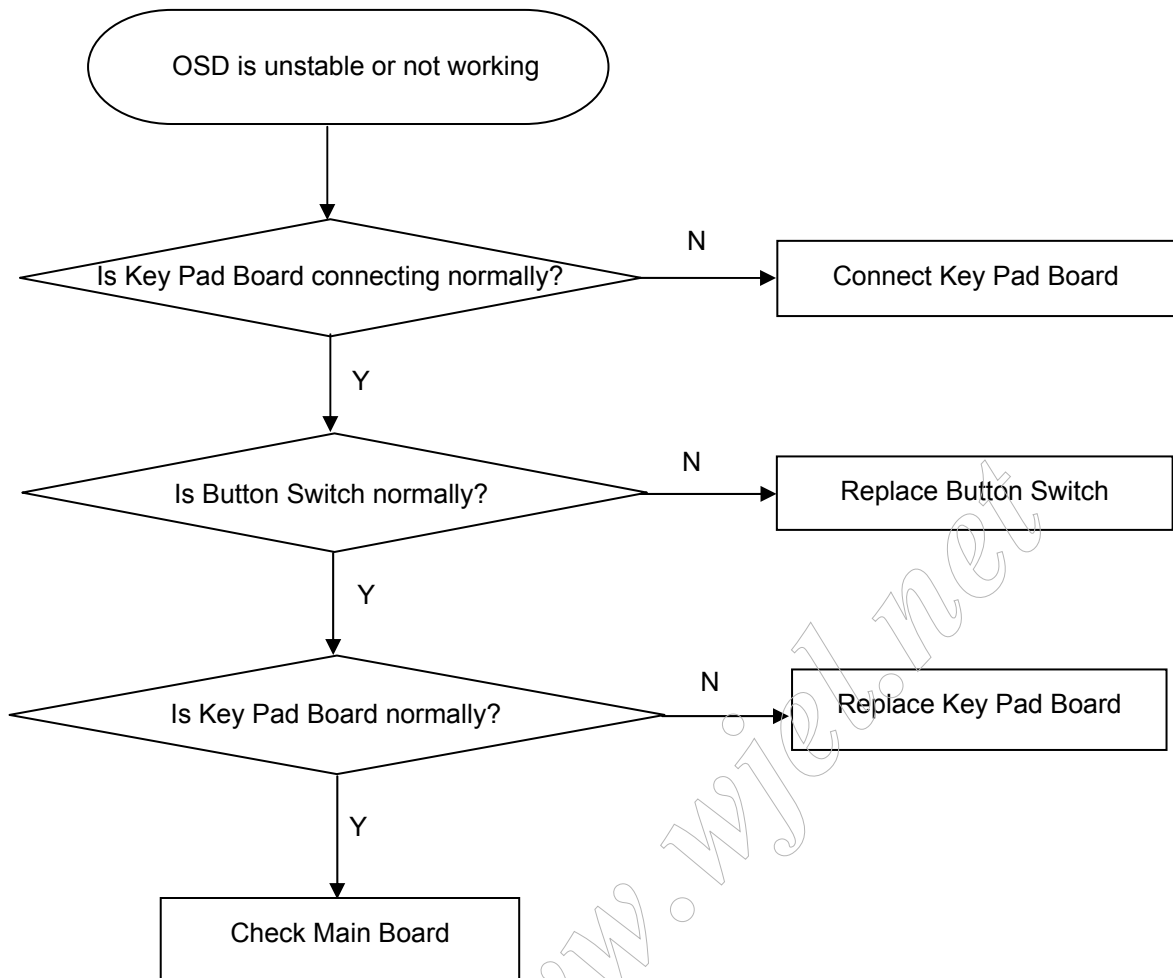

<http://www.wjcl.net>

9. White- Balance, Luminance Adjustment

Approximately 30 minutes should be allowed for warm up before proceeding white balance adjustment.

Before started adjust white balance , please set the Chroma-7120 MEM Channel 3 to Warm (6500K) color, MEM Channel 4 to Normal (7500K) color, MEM Channel 9 to Cool (9300K) color , and MEM Channel 10 to sRGB color (our Warm color parameter is $x = 313 \pm 25$, $y = 329 \pm 25$, $Y=200\text{cd/m}^2(\text{typ})$; Normal color parameter is $x = 299 \pm 20$, $y = 315 \pm 20$, $Y=200\text{cd/m}^2(\text{typ})$; Cool color parameter is $x = 283 \pm 25$, $y = 297 \pm 25$, $Y \geq 170\text{cd/m}^2(\text{typ})$; sRGB color parameter is $x = 313 \pm 25$, $y = 329 \pm 25$, $Y = 160 \pm 10\text{cd/m}^2$)

How to setting MEM channel you can reference to chroma 7120 user guide or simple use " SC" key and " NEXT" Key to modify xyY value and use "ID" key to modify the TEXT description Following is the procedure to do white-balance adjust .

2. Setting the color temp. you want

A. MEM.CHANNEL 3 (Warm color):

Warm color temp. parameter is $x = 313 \pm 25$, $y = 329 \pm 25$, $Y=200\text{cd/ m}^2(\text{typ})$

B. MEM.CHANNEL 4 (Normal color):

Normal color temp. parameter is $x = 299 \pm 25$, $y = 315 \pm 25$, $Y=200\text{cd/ m}^2(\text{typ})$

C. MEM.CHANNEL 9(Cool color):

Cool color temp. parameter is $x = 283 \pm 25$, $y = 297 \pm 25$, $Y \geq 170\text{cd/m}^2(\text{typ})$

D. MEM.CHANNEL 10 (sRGB color):

sRGB color temp. parameter is $x = 313 \pm 25$, $y = 329 \pm 25$, $Y = 160 \pm 10\text{cd/m}^2$

3. Into Factory mode of ASUS VK222U/S:

Press the MENU button, pull out the power cord, and then plug the power cord. Then the factory OSD will be at the left top of the panel.

4. Bias adjustment:

Set the **Contrast**  to 50; Adjust the **Brightness**  to 80.

5. Gain adjustment:

Move cursor to "-F-" and press MENU key

A. Adjust Warm (6500K) color-temperature

1. Switch the chroma-7120 to **RGB-Mode** (with press "MODE" button)
2. Switch the MEM.channel to Channel 3 (with up or down arrow on chroma 7120)
3. The LCD-indicator on chroma 7120 will show $x = 313 \pm 25$, $y = 329 \pm 25$, $Y=200\text{cd/m}^2(\text{typ})$
4. Adjust the RED on factory window until chroma 7120 indicator reached the value $R=100$
5. Adjust the GREEN on factory window until chroma 7120 indicator reached the value $G=100$
6. Adjust the BLUE on factory window until chroma 7120 indicator reached the value $B=100$
7. Repeat above procedure (item 4,5,6) until chroma 7120 RGB value meet the tolerance $=100 \pm 2$

B. Adjust Normal (7500K) color-temperature

1. Switch the chroma-7120 to **RGB-Mode** (with press "MODE" button)
2. Switch the MEM.channel to Channel 4(with up or down arrow on chroma 7120)
3. The LCD-indicator on chroma 7120 will show $x = 299 \pm 25$, $y = 315 \pm 25$, $Y=200\text{cd/m}^2(\text{typ})$

4. Adjust the RED on factory window until chroma 7120 indicator reached the value R=100
 5. Adjust the GREEN on factory window until chroma 7120 indicator reached the value G=100
 6. Adjust the BLUE on factory window until chroma 7120 indicator reached the value B=100
 7. Repeat above procedure (item 4,5,6) until chroma 7120 RGB value meet the tolerance =100±2
- C. Adjust Cool (9300K) color-temperature
1. Switch the Chroma-7120 to **RGB-Mode** (with press "MODE" button)
 2. Switch the MEM. Channel to Channel 9 (with up or down arrow on chroma 7120)
 3. The LCD-indicator on chroma 7120 will show $x = 283 \pm 25$, $y = 297 \pm 25$, $Y \geq 170 \text{cd/m}^2$ (typ)
 4. Adjust the RED on factory window until chroma 7120 indicator reached the value R=100
 5. Adjust the GREEN on factory window until chroma 7120 indicator reached the value G=100
 6. Adjust the BLUE on factory window until chroma 7120 indicator reached the value B=100
 7. Repeat above procedure (item 4,5,6) until chroma 7120 RGB value meet the tolerance =100±2
- D. Adjust sRGB color-temperature
1. Switch the chroma-7120 to **RGB-Mode** (with press "MODE" button)
 2. Switch the MEM.channel to Channel 10 (with up or down arrow on chroma 7120)
 3. The LCD-indicator on chroma 7120 will show $x = 313 \pm 25$, $y = 329 \pm 25$, $Y = 160 \pm 10 \text{cd/m}^2$
 4. Adjust the RED on factory window until chroma 7120 indicator reached the value R=100
 5. Adjust the GREEN on factory window until chroma 7120 indicator reached the value G=100
 6. Adjust the BLUE on factory window until chroma 7120 indicator reached the value B=100
 7. Repeat above procedure (item 4,5,6) until chroma 7120 RGB value meet the tolerance =100±2
- E. Turn the Power-button off to quit from factory mode.

10. Monitor Exploded View

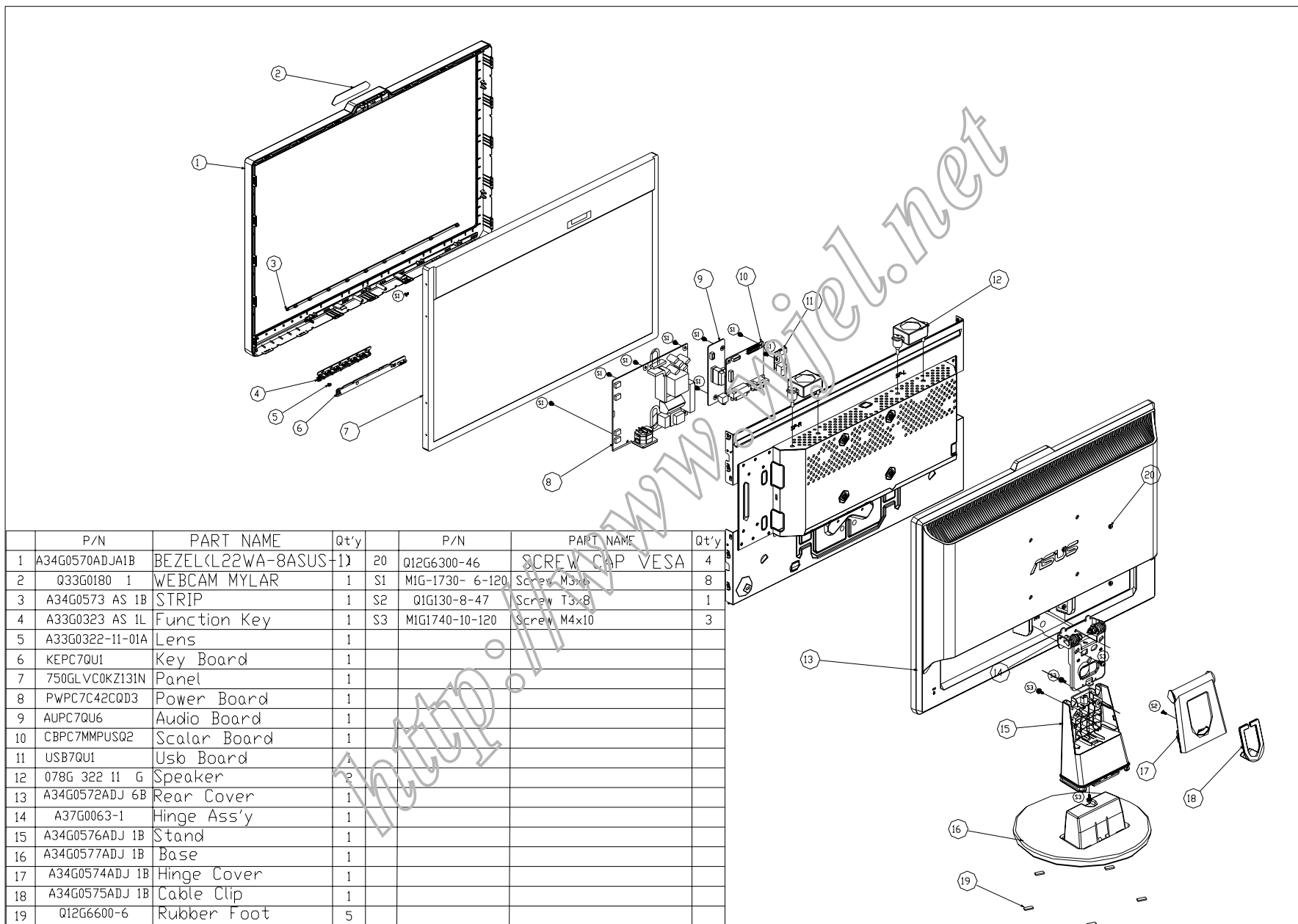

11. BOM List

for VK222U

TC72MPFKW3USDI

Location	Part No.	Description
	017G WCM 3 C	WEBCAM MODULE CKF714221005040L
	019G6014 1	TIE FOR STRIP
	040G 581 26704	SHIPPING LABEL
	040G 58160811A	GREEN DOT LABEL
	040G 581680 1A	WARRANTY LABEL
	041G 68508 A	CONTROL CARD
	044G9003220	CORNER PAPER
	044GH600 1	HANDLE 2
	045G 77 3	PE PACKING
	050G 600 1 W	WHITE STRAP
	050G 600 4	HANDLE 1
	052G 1150 C	INSULATING TAPE
	052G 1185 49	ASUS TAPE
	052G 1186	SMALL TAPE
	052G 1209 A	200MINIUM TAPE
	052G 1211 A	165MINIUM TAPE
	052G 1211 B	AL TAPE
	052G6019 1	INSULATING TAPE
	070GHDCP500HDC	HDCP CODE
E07801	078G 322 11 G	SPEAKER 8 OHM 1.5W L:230 MM 43X18MM
E08904	089G 17356G554	AUDIO CABLE
E08905	089G 175 8 G	FQE41177F USB CABLE 1800MM A+B
E08902	089G 728GAA DB	D-SUB
E08903	089G1748GAA AC	SIGNAL CABLE DVI GREATLAND
E08907	089G176E 55 1	FFC CABLE 55P 195MM P0.5
E08901	089G402A18N CX	POWER CORD
	095G8014 5Q 59	HARNESS 5P-5P 485MM
E09502	095G8014 6X698	WIRE HARNESS 6P(PH)-6P(A1253 HR)
	0M1G1730 6120	SCREW
	0Q1G2420 6120	SCREW
	705GQ734554	22" LCD STAND COVER-BASE ASS'Y
	0M1G1740 10120	SCREW 42A9940008
	A34G0576ADJ 1B	STAND
	A34G0577ADJ 1B 20	BASE
	A37G0063 1	HINGE ASS'Y
	705GQ734555	22" LCD HINGE COVER ASS'Y
	0Q1G 130 8 47 CR3	SCREW

	A34G0574ADJ 1B	HINGE COVER
	A34G0575ADJ 1B	CABLE CLIP
	705GQ734560	22" LCD REAR COVER ASS'Y
	A34G0572ADJ 6B	REAR COVER(L22WA-8ASUS-1)
	Q12G6300 46	SCREW CAP VESA
	705GQ834010	22"LCD BEZEL ASS'Y
	A33G0322 1 1C	LENS
	A33G0323 AS 1L	FUNCTION KEY
	A34G0570ADJA1B 30	BEZEL(L22WA-8ASUS-1)
	A34G0573 AS 1B	STRIP
	750GLVC0KZ131N	PANEL TPM220Z1-PS3 C1A FQ TPV
	A15G0351101	HINGE BKT
	A15G0352101	USB SHIELDING
	AM1G1740 10125	SCREW
	AUPC7QU6	AUDIO BOARD
CN603	033G3802 4	WAFER EH-4
CN602	033G3802 6	WAFER
	040G 457624 1B	LABEL-CPU
U601	056G 616 1	IC E-TDA7496L ST
C601	067G215V471 4N GP	KY25VB470M-CC3 10*16
C602	067G215V471 4N GP	KY25VB470M-CC3 10*16
C605	067G215Y4713RV	LOW E.S.R 470UF +-20% 16V
C607	067G215Y4713RV	LOW E.S.R 470UF +-20% 16V
C608	067T405V471 3P	EC 105°C CAP 470UF M 16V
CN601	088G 30210K E	PHONE JACK 5PIN
Q602	057G 414 2	MPS3906
R617	061G 17236252T	3600OHM 5% 1/4W
R607	061G 60210252T	CFR 1K OHM +-5% 1/6W
R608	061G 60210252T	CFR 1K OHM +-5% 1/6W
R619	061G 60210352T	CFR 10KOHM +-5% 1/6W
R620	061G 60210352T	CFR 10KOHM +-5% 1/6W
R621	061G 60210352T	CFR 10KOHM +-5% 1/6W
R622	061G 60210352T	CFR 10KOHM +-5% 1/6W
R603	061G 60218352T	18KOHM 5% 1/6
R601	061G 60218352T	18KOHM 5% 1/6
R610	061G 60220352T	CFR 20K OHM+-5% 1/6W
R611	061G 60220352T	CFR 20K OHM+-5% 1/6W
R602	061G 60220452T	200KOHM 5% 1/6W
R612	061G 60222452T	220KOHM 5% 1/6W
C604	064G178J474 0T6951	CL21X. 0.47UF 50V +-5%
C606	064G178J474 0T6951	CL21X. 0.47UF 50V +-5%
C611	065G 444101 5T	100 PF 10% 50V Y5P

C612	065G 444101 5T	100 PF 10% 50V Y5P
C603	065G 450104 7T	0.1UF +80-20% 50V Y5V
C609	067G215Y1097NT	EC 1.0UF 50V KY50VB1M-TP5 5*11MM
C613	067G215Y1097NT	EC 1.0UF 50V KY50VB1M-TP5 5*11MM
C614	067G215Y1097NT	EC 1.0UF 50V KY50VB1M-TP5 5*11MM
C610	067G215Y1097NT	EC 1.0UF 50V KY50VB1M-TP5 5*11MM
ZD603	093G 39 7752T	HZ5C1-E
D601	093G 64 1152T	1N4148
D602	093G 64 1152T	1N4148
	715G2767 1	AUDIO-BOARD PCB FR-1 35*104.5 5PCS/PNL
	Q90G6258 2	HEAT SINK
	CBPC7MMPUSQ2	MAIN BOARD
CN403	033G3802 6	WAFER
CN701	033G3802 9	WAFER 9P RIGHT ANELE PITCH
	040G 45762412B	CBPC LABEL
R702	061G152M339 64	CHIPR 3.3 OHM +-5% 2W
CN405	088G 35315F H	D-SUB 15PIN
CN406	088G 35424F C	DVI 24PIN CONN F WITH SCREWS
X401	093G 2253B H	XAT01431AFI1H-3OHX AT-49 14.31818MHZ
CN407	033G801955Y H HC	0.5 PITCH 55P SMT
U401	056G 562199	IC TSUMO5RCWHQ-LF PQFP-128
U701	056G 56327A	IC AP1117E18LA SOT223-3L ANACHIP
U702	056G 585 4A	AP1117E33LA
U404	056G1133 34	M24C02-WMN6TP
U405	056G1133 34	M24C02-WMN6TP
U403	056G1133 89	IC AF24BC16-SI 16K SOIC-8
U402	056G1133713	IC PM25LV010A-100SCE SOIC-8
Q402	057G 417511	MMBT3904
Q406	057G 417511	MMBT3904
Q703	057G 417511	MMBT3904
Q401	057G 417512	MMBT3906
Q403	057G 417512	MMBT3906
Q411	057G 417512	MMBT3906
Q412	057G 763501	FET AM2321P ANALOG POWER
R407	061G0402000	RST CHIPR 0 OHM +-5% 1/16W
R410	061G0402000	RST CHIPR 0 OHM +-5% 1/16W
R462	061G0402100	RST CHIPR 10 OHM +-5% 1/16W
R463	061G0402100	RST CHIPR 10 OHM +-5% 1/16W
R464	061G0402100	RST CHIPR 10 OHM +-5% 1/16W
R465	061G0402100	RST CHIPR 10 OHM +-5% 1/16W
R466	061G0402100	RST CHIPR 10 OHM +-5% 1/16W
R467	061G0402100	RST CHIPR 10 OHM +-5% 1/16W

R468	061G0402100	RST CHIPR 10 OHM +-5% 1/16W
R469	061G0402100	RST CHIPR 10 OHM +-5% 1/16W
R411	061G0402101	RST CHIPR 100 OHM +-5% 1/16W
R418	061G0402101	RST CHIPR 100 OHM +-5% 1/16W
R420	061G0402101	RST CHIPR 100 OHM +-5% 1/16W
R427	061G0402101	RST CHIPR 100 OHM +-5% 1/16W
R428	061G0402101	RST CHIPR 100 OHM +-5% 1/16W
R429	061G0402101	RST CHIPR 100 OHM +-5% 1/16W
R441	061G0402101	RST CHIPR 100 OHM +-5% 1/16W
R442	061G0402101	RST CHIPR 100 OHM +-5% 1/16W
R443	061G0402101	RST CHIPR 100 OHM +-5% 1/16W
R453	061G0402101	RST CHIPR 100 OHM +-5% 1/16W
R454	061G0402101	RST CHIPR 100 OHM +-5% 1/16W
R483	061G0402101	RST CHIPR 100 OHM +-5% 1/16W
R488	061G0402101	RST CHIPR 100 OHM +-5% 1/16W
R499	061G0402101	RST CHIPR 100 OHM +-5% 1/16W
R455	061G0402101	RST CHIPR 100 OHM +-5% 1/16W
R456	061G0402101	RST CHIPR 100 OHM +-5% 1/16W
R470	061G0402102	RST CHIPR 1 KOHM +-5% 1/16W
R447	061G0402102	RST CHIPR 1 KOHM +-5% 1/16W
R446	061G0402102	RST CHIPR 1 KOHM +-5% 1/16W
R445	061G0402102	RST CHIPR 1 KOHM +-5% 1/16W
R487	061G0402103	RST CHIPR 10 KOHM +-5% 1/16W
R452	061G0402103	RST CHIPR 10 KOHM +-5% 1/16W
R426	061G0402103	RST CHIPR 10 KOHM +-5% 1/16W
R425	061G0402103	RST CHIPR 10 KOHM +-5% 1/16W
R424	061G0402103	RST CHIPR 10 KOHM +-5% 1/16W
R415	061G0402103	RST CHIPR 10 KOHM +-5% 1/16W
R413	061G0402103	RST CHIPR 10 KOHM +-5% 1/16W
R408	061G0402103	RST CHIPR 10 KOHM +-5% 1/16W
R404	061G0402103	RST CHIPR 10 KOHM +-5% 1/16W
R406	061G0402103	RST CHIPR 10 KOHM +-5% 1/16W
R708	061G0402103	RST CHIPR 10 KOHM +-5% 1/16W
R461	061G0402103	RST CHIPR 10 KOHM +-5% 1/16W
R711	061G0402103	RST CHIPR 10 KOHM +-5% 1/16W
R493	061G0402103	RST CHIPR 10 KOHM +-5% 1/16W
R494	061G0402103	RST CHIPR 10 KOHM +-5% 1/16W
R497	061G0402103	RST CHIPR 10 KOHM +-5% 1/16W
R431	061G0402103	RST CHIPR 10 KOHM +-5% 1/16W
R457	061G0402103	RST CHIPR 10 KOHM +-5% 1/16W
R490	061G0402103	RST CHIPR 10 KOHM +-5% 1/16W
R489	061G0402103	RST CHIPR 10 KOHM +-5% 1/16W

R448	061G0402222	RST CHIPR 2.2 KOHM +-5% 1/16W
R458	061G0402222	RST CHIPR 2.2 KOHM +-5% 1/16W
R449	061G0402222	RST CHIPR 2.2 KOHM +-5% 1/16W
R405	061G0402223	RST CHIPR 22 KOHM +-5% 1/16W
R403	061G0402390 0F	RST CHIP 390R 1/16W 1%
R474	061G0402390 1F	RST CHIPR 3.9KOHM +-1% 1/16W
R475	061G0402390 1F	RST CHIPR 3.9KOHM +-1% 1/16W
R419	061G0402471	RST CHIPR 470 OHM +-5% 1/16W
R421	061G0402471	RST CHIPR 470 OHM +-5% 1/16W
R437	061G0402471	RST CHIPR 470 OHM +-5% 1/16W
R422	061G0402472	RST CHIPR 4.7 KOHM +-5% 1/16W
R423	061G0402472	RST CHIPR 4.7 KOHM +-5% 1/16W
R433	061G0402472	RST CHIPR 4.7 KOHM +-5% 1/16W
R444	061G0402472	RST CHIPR 4.7 KOHM +-5% 1/16W
R712	061G0402472	RST CHIPR 4.7 KOHM +-5% 1/16W
R450	061G0402472	RST CHIPR 4.7 KOHM +-5% 1/16W
R451	061G0402472	RST CHIPR 4.7 KOHM +-5% 1/16W
R496	061G0402472	RST CHIPR 4.7 KOHM +-5% 1/16W
R459	061G0402472	RST CHIPR 4.7 KOHM +-5% 1/16W
R460	061G0402472	RST CHIPR 4.7 KOHM +-5% 1/16W
R495	061G0402513	RST CHIP 51K 1/16W 5%
R434	061G0402560	RST CHIP 56R 1/16W 5%
R435	061G0402560	RST CHIP 56R 1/16W 5%
R436	061G0402560	RST CHIP 56R 1/16W 5%
R438	061G0402750	RST CHIPR 75 OHM +-5% 1/16W
R439	061G0402750	RST CHIPR 75 OHM +-5% 1/16W
R440	061G0402750	RST CHIPR 75 OHM +-5% 1/16W
FB401	061G0603000	RST CHIPR 0 OHM +-5% 1/10W
FB410	061G0603000	RST CHIPR 0 OHM +-5% 1/10W
FB411	061G0603000	RST CHIPR 0 OHM +-5% 1/10W
FB412	061G0603000	RST CHIPR 0 OHM +-5% 1/10W
R491	061G0805391	390 OHM 1/10W 1%
C435	065G0402102 32	1000PF +-10% 50V X7R
C428	065G0402104 15	MLCC 0402 0.1UF K 16V X5R
C427	065G0402104 15	MLCC 0402 0.1UF K 16V X5R
C426	065G0402104 15	MLCC 0402 0.1UF K 16V X5R
C412	065G0402104 15	MLCC 0402 0.1UF K 16V X5R
C413	065G0402104 15	MLCC 0402 0.1UF K 16V X5R
C414	065G0402104 15	MLCC 0402 0.1UF K 16V X5R
C415	065G0402104 15	MLCC 0402 0.1UF K 16V X5R
C416	065G0402104 15	MLCC 0402 0.1UF K 16V X5R
C419	065G0402104 15	MLCC 0402 0.1UF K 16V X5R

C420	065G0402104 15	MLCC 0402 0.1UF K 16V X5R
C422	065G0402104 15	MLCC 0402 0.1UF K 16V X5R
C429	065G0402104 15	MLCC 0402 0.1UF K 16V X5R
C714	065G0402104 15	MLCC 0402 0.1UF K 16V X5R
C462	065G0402104 15	MLCC 0402 0.1UF K 16V X5R
C465	065G0402104 15	MLCC 0402 0.1UF K 16V X5R
C445	065G0402104 15	MLCC 0402 0.1UF K 16V X5R
C447	065G0402104 15	MLCC 0402 0.1UF K 16V X5R
C448	065G0402104 15	MLCC 0402 0.1UF K 16V X5R
C449	065G0402104 15	MLCC 0402 0.1UF K 16V X5R
C450	065G0402104 15	MLCC 0402 0.1UF K 16V X5R
C451	065G0402104 15	MLCC 0402 0.1UF K 16V X5R
C452	065G0402104 15	MLCC 0402 0.1UF K 16V X5R
C453	065G0402104 15	MLCC 0402 0.1UF K 16V X5R
C454	065G0402104 15	MLCC 0402 0.1UF K 16V X5R
C430	065G0402104 15	MLCC 0402 0.1UF K 16V X5R
C439	065G0402104 15	MLCC 0402 0.1UF K 16V X5R
C440	065G0402104 15	MLCC 0402 0.1UF K 16V X5R
C441	065G0402104 15	MLCC 0402 0.1UF K 16V X5R
C456	065G0402104 15	MLCC 0402 0.1UF K 16V X5R
C457	065G0402104 15	MLCC 0402 0.1UF K 16V X5R
C458	065G0402104 15	MLCC 0402 0.1UF K 16V X5R
C701	065G0402104 15	MLCC 0402 0.1UF K 16V X5R
C704	065G0402104 15	MLCC 0402 0.1UF K 16V X5R
C709	065G0402104 15	MLCC 0402 0.1UF K 16V X5R
C711	065G0402104 15	MLCC 0402 0.1UF K 16V X5R
C713	065G0402104 15	MLCC 0402 0.1UF K 16V X5R
C411	065G0402104 15	MLCC 0402 0.1UF K 16V X5R
C401	065G0402104 15	MLCC 0402 0.1UF K 16V X5R
C402	065G0402104 15	MLCC 0402 0.1UF K 16V X5R
C404	065G0402104 15	MLCC 0402 0.1UF K 16V X5R
C405	065G0402104 15	MLCC 0402 0.1UF K 16V X5R
C406	065G0402104 15	MLCC 0402 0.1UF K 16V X5R
C407	065G0402104 15	MLCC 0402 0.1UF K 16V X5R
C409	065G0402104 15	MLCC 0402 0.1UF K 16V X5R
C410	065G0402104 15	MLCC 0402 0.1UF K 16V X5R
C463	065G0402105 A5	CAP 0402 1UF K 10V X5R
C443	065G0402221 31	CAP:CER 220PF 5% 50V SM
C446	065G0402224A5T	MLCC 0402 0.22UF K 10V X
C444	065G0402224A5T	MLCC 0402 0.22UF K 10V X
C417	065G0402224A5T	MLCC 0402 0.22UF K 10V X
C425	065G0402224A5T	MLCC 0402 0.22UF K 10V X

C421	065G0402270 31	0402 27PF J 50V NPO
C423	065G0402270 31	0402 27PF J 50V NPO
C442	065G0402330 31	33PF +-50% 50V NPO
C438	065G0402473 12	CHIP 0.047UF 16V X7R
C437	065G0402473 12	CHIP 0.047UF 16V X7R
C436	065G0402473 12	CHIP 0.047UF 16V X7R
C434	065G0402473 12	CHIP 0.047UF 16V X7R
C433	065G0402473 12	CHIP 0.047UF 16V X7R
C432	065G0402473 12	CHIP 0.047UF 16V X7R
FB409	071G 56G151 MD	CHIP BEAD
FB405	071G 56K121	CHIP BEAD
FB403	071G 56K121	CHIP BEAD
FB402	071G 56K121	CHIP BEAD
FB421	071G 56K121	CHIP BEAD
D413	093G 64 42 P	BAV70 SOT23 BY PAN JIT
D407	093G 64 42 P	BAV70 SOT23 BY PAN JIT
D403	093G 6433P	BAV99
D404	093G 6433P	BAV99
D405	093G 6433P	BAV99
D417	093G 6433P	BAV99
D418	093G 6433P	BAV99
D419	093G 6433P	BAV99
D420	093G 6433P	BAV99
D421	093G 6433P	BAV99
D422	093G 6433P	BAV99
D423	093G 6433P	BAV99
D424	093G 6433P	BAV99
D412	093G 39S 24 T	RLZ 5.6B LLDS
D411	093G 39S 24 T	RLZ 5.6B LLDS
D409	093G 39S 24 T	RLZ 5.6B LLDS
D408	093G 39S 24 T	RLZ 5.6B LLDS
D406	093G 39S 24 T	RLZ 5.6B LLDS
D414	093G 39S 34 T	UDZSNP5.6B ROHM
D415	093G 39S 34 T	UDZSNP5.6B ROHM
D401	093G 39S 34 T	UDZSNP5.6B ROHM
D402	093G 39S 34 T	UDZSNP5.6B ROHM
D410	093G 39S 34 T	UDZSNP5.6B ROHM
D425	093G 39S 34 T	UDZSNP5.6B ROHM
D416	093G 39S 34 T	UDZSNP5.6B ROHM
D704	093G2004 2	DIODE SR24
	715G2670 1 2	MAIN BOARD PCB FR4 80X67X1.6MM DS
	KEPC7QU1	KEY BOARD

SW002	077G 605 1 CJ	TSAB-2
SW001	077G 605 1 CJ	TSAB-2
SW005	077G 605 1 CJ	TSAB-2
SW006	077G 605 1 CJ	TSAB-2
SW004	077G 605 1 CJ	TSAB-2
SW003	077G 605 1 CJ	TSAB-2
CN001	033G8032 6F HR	CONNECTOR
R005	061G0603000	RST CHIPR 0 OHM +-5% 1/10W
R002	061G0603000	RST CHIPR 0 OHM +-5% 1/10W
R003	061G0603100 1F	RST CHIPR 1 KOHM +-1% 1/10W
R004	061G0603200 1F	RST CHIPR 2 KOHM +-1% 1/10W
R001	061G0603200 1F	RST CHIPR 2 KOHM +-1% 1/10W
C003	065G0603104 37	CHIP 0.1UF 50V/Y5V
C005	065G0603104 37	CHIP 0.1UF 50V/Y5V
C001	065G0603104 37	CHIP 0.1UF 50V/Y5V
C002	065G0603104 37	CHIP 0.1UF 50V/Y5V
C004	065G0603104 37	CHIP 0.1UF 50V/Y5V
LED01	081G 14 12 GP	LED
ZD003	093G 39S 24 T	RLZ 5.6B LLDS
ZD001	093G 39S 24 T	RLZ 5.6B LLDS
ZD002	093G 39S 24 T	RLZ 5.6B LLDS
	715G2900 1	KEY BOARD PCB FR4 147X12X1.6MM DS
	PWPC7C42CQD3	POWER BOARD
GND1	009G6005 1	GROUND TERMINAL
CN801	033G8021 2E F	WAFER
CN802	033G8021 2E F	WAFER
CN803	033G8021 2E F	WAFER
CN804	033G8021 2E F	WAFER
	040G 45762420A	LABEL 25X6MM
	051G 6 4503	GLUE_RTV
IC903	056G 139 3A	IC PC123Y22FZ0F
NR901	061G 58080 WT	8 OHM NCT
R908	061G152M104 64	100KOHM 5% 2W
R914	061G152M228 64	0.22 OHM 5% 2W
C903	063G107K474 6S	CAP X2 0.47UF K 275VAC
C801	065G 6J5096ET	CAP CER 5PF J 6KV
C811	065G 6J5096ET	CAP CER 5PF J 6KV
C902	065G305M1022BP	Y2 1000PF M 250VAC Y5P
C901	065G305M1022BP	Y2 1000PF M 250VAC Y5P
C921	065G306M4722BP	4700PF +-20% 400VAC
C803	067G215D4714KV	E.C 105°C CAP 470UF M 25V ED SERIES
C802	067G215D4714KV	E.C 105°C CAP 470UF M 25V ED SERIES

C918	067G215D6814KV	CAP 105°C 680UF M 25V
C917	067G215D6814KV	CAP 105°C 680UF M 25V
C939	067G215S1024KV	EC 105°C CAP 1000UF M 25V
C915	067G215S4713KV	EC 105°C CAP 470UF M 16V
C905	067G215Z12115K	ELCAP 105°C 120UF M 450V
L902	073G 174 65 H	LINE FILTER
L901	073G 174 76 H	FILTER
L903	073G 253191 YS	CHOKO COIL 1.1UH YS04110055
L904	073G 253191 YS	CHOKO COIL 1.1UH YS04110055
T901	080GL19T 23 YS	X'FMR 510UH YS04160061
T801	080GL19T 24 YS	X'FMR 740MH YS04170157
T802	080GL19T 24 YS	X'FMR 740MH YS04170157
CN901	087G 501 37 S	AC INLET ST-01DG-B2K-K
BD901	093G 50460 28	BRIDGE DIODE KBP208G LITEON
CN902	095G 825 9D 1	HARNESS 9P(SCN)-9P+6P 230MM
	705G 193 57 01	Q901 ASS'Y
	051G 200 1	OIL FOR DISAPPEAR
Q901	057G 667 21	STP10NK70ZFP
	090G6263 1	HEAT SINK
	AM1G1730 8120 GP	SCREW
	705G 193 93 01	D906 ASS'Y
	051G 200 1	OIL FOR DISAPPEAR
D906	093G 60218	SB10100FCT
	AM1G1730 8120 GP	SCREW
	Q90G6274 2	HEAT SINK
	705GQ9KA 93002	D905 ASS"Y
	051G 200 1	OIL FOR DISAPPEAR
	090G6084 1	HEAT SINK
D905	093G 60257	DIODE SB1060FCT ITO-220AB BY PAN JIT
	0M1G1730 8120	SCREW
IC801	056G 379 22	IC TL494IDR SOIC-16
IC901	056G 379 71	IC TEA1530AT/N2 SO-8 NXP
Q801	057G 417 4	PMBS3904/PHILIPS-SMT(04)
Q806	057G 417 4	PMBS3904/PHILIPS-SMT(04)
Q807	057G 417 4	PMBS3904/PHILIPS-SMT(04)
Q811	057G 417 4	PMBS3904/PHILIPS-SMT(04)
Q902	057G 417 4	PMBS3904/PHILIPS-SMT(04)
Q812	057G 417 6	PMBS3906/PHILIPS-SMT(06)
Q804	057G 417 6	PMBS3906/PHILIPS-SMT(06)
Q809	057G 759 2	RK7002
Q810	057G 759 2	RK7002
Q808	057G 760 4B	PDTA144WK SOT346

Q805	057G 760 5B	PDTC144WK SOT346
Q802	057G 763 14	AM9945N
Q803	057G 763 14	AM9945N
R809	061G0603100 1F	RST CHIPR 1 KOHM +-1% 1/10W
R812	061G0603100 1F	RST CHIPR 1 KOHM +-1% 1/10W
R818	061G0603100 1F	RST CHIPR 1 KOHM +-1% 1/10W
R821	061G0603100 1F	RST CHIPR 1 KOHM +-1% 1/10W
R822	061G0603100 1F	RST CHIPR 1 KOHM +-1% 1/10W
R824	061G0603100 1F	RST CHIPR 1 KOHM +-1% 1/10W
R826	061G0603100 1F	RST CHIPR 1 KOHM +-1% 1/10W
R925	061G0603100 1F	RST CHIPR 1 KOHM +-1% 1/10W
R942	061G0603100 1F	RST CHIPR 1 KOHM +-1% 1/10W
R926	061G0603100 2F	RST CHIPR 10 KOHM +-1% 1/10W
R834	061G0603100 2F	RST CHIPR 10 KOHM +-1% 1/10W
R833	061G0603100 2F	RST CHIPR 10 KOHM +-1% 1/10W
R832	061G0603100 2F	RST CHIPR 10 KOHM +-1% 1/10W
R828	061G0603100 2F	RST CHIPR 10 KOHM +-1% 1/10W
R817	061G0603100 2F	RST CHIPR 10 KOHM +-1% 1/10W
R813	061G0603100 2F	RST CHIPR 10 KOHM +-1% 1/10W
R808	061G0603100 2F	RST CHIPR 10 KOHM +-1% 1/10W
R835	061G0603105	RST CHIPR 1 MOHM +-5% 1/10W
R862	061G0603105	RST CHIPR 1 MOHM +-5% 1/10W
R861	061G0603130 3F	RST CHIPR 130KOHM +-1% 1/10W
R801	061G0603150 1F	RST CHIPR 1.5 KOHM +-1% 1/10W
R814	061G0603150 1F	RST CHIPR 1.5 KOHM +-1% 1/10W
R815	061G0603150 1F	RST CHIPR 1.5 KOHM +-1% 1/10W
R816	061G0603150 1F	RST CHIPR 1.5 KOHM +-1% 1/10W
R924	061G0603152	RST CHIPR 1.5 KOHM +-5% 1/10W
R811	061G0603240 1F	RST CHIPR 2.4 KOHM +-1% 1/10W
R831	061G0603240 1F	RST CHIPR 2.4 KOHM +-1% 1/10W
R930	061G0603240 1F	RST CHIPR 2.4 KOHM +-1% 1/10W
R940	061G0603330 2F	RST CHIPR 33 KOHM +-1% 1/10W
R927	061G0603360 1F	RST CHIPR 3.6 KOHM +-1% 1/10W
R827	061G0603362	RST CHIPR 3.6 KOHM +-5% 1/10W
R823	061G0603362	RST CHIPR 3.6 KOHM +-5% 1/10W
R819	061G0603362	RST CHIPR 3.6 KOHM +-5% 1/10W
R820	061G0603470 2F	RST CHIPR 47 KOHM +-1% 1/10W
R803	061G0603564	RST CHIPR 560 KOHM +-5% 1/10W
R806	061G0603680 2F	RST CHIPR 68 KOHM +-1% 1/10W
R807	061G0603680 2F	RST CHIPR 68 KOHM +-1% 1/10W
R841	061G0603680 2F	RST CHIPR 68 KOHM +-1% 1/10W
R853	061G0603680 2F	RST CHIPR 68 KOHM +-1% 1/10W

R854	061G0603680 2F	RST CHIPR 68 KOHM +-1% 1/10W
R851	061G0603820 1F	RST CHIPR 8.2 KOHM +-1% 1/10W
R850	061G0805000	0 OHM 1/10W
R839	061G0805000	0 OHM 1/10W
R804	061G0805101	RST CHIPR 100 OHM +-5% 1/8W
R911	061G0805102	RST CHIPR 1KOHM +-5% 1/8W
R917	061G0805102	RST CHIPR 1KOHM +-5% 1/8W
R929	061G0805102	RST CHIPR 1KOHM +-5% 1/8W
R938	061G0805103	10 KOHM 1/10W
R916	061G0805152	RST CHIPR 1.5 KOHM +-5% 1/8W
R829	061G0805220	22&8 1/10W
R825	061G0805220	22&8 1/10W
R912	061G0805220 2F	RST CHIPR 22 KOHM +-1% 1/8W
R915	061G0805224	RST CHIPR 220 KOHM +-5% 1/8W
R837	061G0805473	RST CHIPR 47 KOHM +-5% 1/8W
R810	061G0805510 2F	RST CHIPR 51 KOHM +-1% 1/8W
R931	061G0805822	RST CHIPR 8.2 KOHM +-5% 1/8W
JR801	061G1206000	RST CHIPR 0 OHM +-5% 1/4W
JR802	061G1206000	RST CHIPR 0 OHM +-5% 1/4W
JR803	061G1206000	RST CHIPR 0 OHM +-5% 1/4W
JR804	061G1206000	RST CHIPR 0 OHM +-5% 1/4W
JR805	061G1206000	RST CHIPR 0 OHM +-5% 1/4W
JR807	061G1206000	RST CHIPR 0 OHM +-5% 1/4W
JR808	061G1206000	RST CHIPR 0 OHM +-5% 1/4W
JR809	061G1206000	RST CHIPR 0 OHM +-5% 1/4W
JR901	061G1206000	RST CHIPR 0 OHM +-5% 1/4W
R967	061G1206000 4	RST CHIPR 0 OHM +-5% 1/4W
F902	061G1206000 4	RST CHIPR 0 OHM +-5% 1/4W
F801	061G1206000 4	RST CHIPR 0 OHM +-5% 1/4W
R909	061G1206100	RST CHIP 10R 1/4W 5%
R910	061G1206100	RST CHIP 10R 1/4W 5%
R918	061G1206101	100 1206
R919	061G1206101	100 1206
R920	061G1206101	100 1206
R935	061G1206101	100 1206
R961	061G1206101	100 1206
R962	061G1206101	100 1206
R921	061G1206102	RST CHIPR 1 KOHM +-5% 1/4W
R922	061G1206102	RST CHIPR 1 KOHM +-5% 1/4W
R923	061G1206102	RST CHIPR 1 KOHM +-5% 1/4W
R928	061G1206102	RST CHIPR 1 KOHM +-5% 1/4W
R855	061G1206150	RST CHIPR 15 OHM +-5% 1/4W

R857	061G1206150	RST CHIPR 15 OHM +-5% 1/4W
R856	061G1206150	RST CHIPR 15 OHM +-5% 1/4W
R858	061G1206150	RST CHIPR 15 OHM +-5% 1/4W
R904	061G1206472	RST CHIPR 4.7 KOHM +-5% 1/4W
R932	061G1206472	RST CHIPR 4.7 KOHM +-5% 1/4W
R933	061G1206472	RST CHIPR 4.7 KOHM +-5% 1/4W
R901	061G1206684	RST CHIPR 680 KOHM +-5% 1/4W
R902	061G1206684	RST CHIPR 680 KOHM +-5% 1/4W
R903	061G1206684	RST CHIPR 680 KOHM +-5% 1/4W
C842	065G0603103 12	CHIP 0.01UF 16V X7R
C924	065G0603103 12	CHIP 0.01UF 16V X7R
C834	065G0603104 22	CHIP 0.1UF 25V X7R
C825	065G0603104 22	CHIP 0.1UF 25V X7R
C821	065G0603104 22	CHIP 0.1UF 25V X7R
C807	065G0603104 22	CHIP 0.1UF 25V X7R
C823	065G0603222 22	CHIP 2200PF 25V X7R
C819	065G0603222 22	CHIP 2200PF 25V X7R
C816	065G0603222 22	CHIP 2200PF 25V X7R
C815	065G0603222 22	CHIP 2200PF 25V X7R
C910	065G0805102 32	CHIP 1000P 50VX7R 0805
C931	065G0805104 32	CHIP 0.1U 50V X7R
C930	065G0805104 32	CHIP 0.1U 50V X7R
C916	065G0805104 32	CHIP 0.1U 50V X7R
C907	065G0805104 32	CHIP 0.1U 50V X7R
C824	065G0805104 32	CHIP 0.1U 50V X7R
C805	065G0805104 32	CHIP 0.1U 50V X7R
C822	065G0805105 22	CHIP 1UF 25V X7R 0805
C928	065G0805122 31	CHIP CAP 0805 1200PF J 50V NPO
C841	065G0805152 31	1.5NF/50V
C838	065G0805152 31	1.5NF/50V
C840	065G0805152 31	1.5NF/50V
C839	065G0805152 31	1.5NF/50V
C820	065G080522131G	220PF 50V NPO 2%
C911	065G0805224 22	CAIP CAP 0.22 UF 25V X7R
C909	065G0805224 32	0.22UF,K,50V,X7R
C845	065G0805225 12	CHIP 2.2UF 16V X7R 0805
C912	065G1206102 72	CHIP 1000PF 500V X7R
C929	065G1206102 72	CHIP 1000PF 500V X7R
D805	093G 64 38 P	BAW56
D808	093G 64 38 P	BAW56
D903	093G 64 38 P	BAW56
D916	093G 6432S	IN4148W

D915	093G 6432S	IN4148W
D817	093G 6432S	IN4148W
D814	093G 6432S	IN4148W
D809	093G 6432S	IN4148W
D806	093G 6432S	IN4148W
D801	093G 6433P	BAV99
D802	093G 6433P	BAV99
D803	093G 6433P	BAV99
D804	093G 6433P	BAV99
ZD922	093G 39S 25 T	RLZ5.1B LLDS
ZD902	093G 39S 61 T	DIODE RLZ16B ROHM
ZD921	093G 39S 61 T	DIODE RLZ16B ROHM
CN901	006G 31500	EYELET
T901	006G 31502	1.5MM RIVET
NR901	006G 31502	1.5MM RIVET
IC904	056G 158 12	KIA431A-AT/P TO-92
C906	065G 2K152 1T6052	1.5NF/2KV Y5P +-10%
C938	065G 2K152 1T6052	1.5NF/2KV Y5P +-10%
C908	067G215Y2207KT	CAP 105°C 22UF M 50V KINGNICH
FB901	071G 55 29	FERRITE BEAD
F901	084G 55 1W	FUSE 4A 250V WICKMANN
D901	093G 6038P52T	PS102R
D900	093G1100 1152T	DIODE PR1007R 1A/1000V DO-41
	715G2538 4	POWER BOARD PCB FR-1 160*124MM SS
	Q07G 8 3 54	COMPOUND PALLET
	Q15G0267201	SHIELDING
	Q33G0180 1	WEBCAM MYLAR
	Q40G0001624 4A	PALLET LABEL
	Q40G000268066A	SPLENDID LABEL FOR VK222V
	Q40G000268070A	TRY ME LABEL FOR VK22
	Q41G780068027B	US WARRANTY CARD NON ZBD
	Q44G6002CP215A	PAPER CAP
	Q44GC037680 2A	22 LCD ASUS CARTON
	Q44GC048101	EPS
	Q44GC048201	EPS
	Q45G 76 28V13 R	PE BAG
	Q45G 88606 S R	PE BAG FOR BASE
	Q45G 88609 74	EPE BAG
	Q52G6020 29	PROTECT FILM
	Q90G0150 1	HEAT SINK
	USB7QU1	USB BOARD
CN003	033G3802 5H	WAFER 5P RIGHT ANELE PITCH

CN002	088G 351 2B TN	USB CONN
R007	061G0603000	RST CHIPR 0 OHM +-5% 1/10W
R006	061G0603000	RST CHIPR 0 OHM +-5% 1/10W
C007	065G0603104 37	CHIP 0.1UF 50V/Y5V
C006	065G0603104 37	CHIP 0.1UF 50V/Y5V
C008	065G1206106 17	MLCC 10 UF Z 16V Y5V
FB001	071G 56K121 M	CHIP BEAD
ZD005	093G 64 49 SU	DIODE ESD EGA 10603V05A1-B INPAQ
ZD004	093G 64 49 SU	DIODE ESD EGA 10603V05A1-B INPAQ
	715G2901 1	SIDE BOARD PCB FR-4 22X37X1.6MM DS
	045G 76 28 RN	PE BAG FOR MANUAL
	070G2000500 AS	CD-ROM
	Q41G780068041A	VK221 222 QSG FOR NON EU
	040G 457834 4A GP	S/N LABEL FOR ID
	040G 457842 2B	PALLET LABEL
	040G 58162435A	P/N LABEL
	040G 582680 3A	PALLET LABEL
	040G 582680 4A	CARTON LABEL
	Q40G 22N680 9A	RATING LABEL

<http://www.wjel.net>

for VK222S

TC72MPFBW3USAI

Location	Part No.	Description
	017G WCM 3 C	WEBCAM MODULE CKF714221005040L
	019G6014 1	TIE FOR STRIP
	040G 581 26704	SHIPPING LABEL
	040G 58160811A	GREEN DOT LABEL
	040G 581680 1A	WARRANTY LABEL
	041G 68508 A	CONTROL CARD
	044G9003220	CORNER PAPER
	044GH600 1	HANDLE 2
	045G 77 3	PE PACKING
	050G 600 1 W	WHITE STRAP
	050G 600 4	HANDLE 1
	052G 1150 C	INSULATING TAPE
	052G 1185 49	ASUS TAPE
	052G 1186	SMALL TAPE
	052G 1209 A	200MINIUM TAPE
	052G 1211 A	165MINIUM TAPE
	052G6019 1	INSULATING TAPE
E07801	078G 322 11 G	SPEAKER 8 OHM 1.5W L:230 MM 43X18MM
E08904	089G 17356G554	AUDIO CABLE
E08905	089G 175 8 G	FQE41177F USB CABLE 1800MM A+B
E08902	089G 728GAA DB	D-SUB
E08907	089G176E 55 1	FFC CABLE 55P 195MM P0.5
E08901	089G404A18N YH	POWER CORD(32E1818018/32-D022217)
	095G8014 5Q 59	HARNESS 5P-5P 485MM
E09502	095G8014 6X698	WIRE HARNESS 6P(PH)-6P(A1253 HR)
	0M1G1730 6120	SCREW
	0Q1G2420 6120	SCREW
	705GQ734554	22" LCD STAND COVER-BASE ASS'Y
	0M1G1740 10120	SCREW 42A9940008
	A34G0576ADJ 1B	STAND
	A34G0577ADJ 1B 20	BASE
	A37G0063 1	HINGE ASS'Y
	705GQ734555	22" LCD HINGE COVER ASS'Y
	0Q1G 130 8 47 CR3	SCREW
	A34G0574ADJ 1B	HINGE COVER
	A34G0575ADJ 1B	CABLE CLIP
	705GQ734559	22" LCD REAR COVER ASS'Y

	A34G0572ADJ 5B	REAR COVER(L22WA-8ASUS-1)
	Q12G6300 46	SCREW CAP VESA
	705GQ834009	22"LCD BEZEL ASS'Y
	A33G0322 1 1C	LENS
	A33G0323 AS 1L	FUNCTION KEY
	A34G0570ADJB1B 30	BEZEL(L22WA-8ASUS-1)
	A34G0573 AS 1B	STRIP
	750GLVC0KZ131N	PANEL TPM220Z1-PS3 C1A FQ TPV
	A15G0351101	HINGE BKT
	A15G0352101	USB SHIELDING
	AM1G1740 10125	SCREW
	AUPC7QU6	AUDIO BOARD
CN603	033G3802 4	WAFER EH-4
CN602	033G3802 6	WAFER
	040G 457624 1B	LABEL-CPU
U601	056G 616 1	IC E-TDA7496L ST
C601	067G215V471 4N GP	KY25VB470M-CC3 10*16
C602	067G215V471 4N GP	KY25VB470M-CC3 10*16
C605	067G215Y4713RV	LOW E.S.R 470UF +-20% 16V
C607	067G215Y4713RV	LOW E.S.R 470UF +-20% 16V
C608	067T405V471 3P	EC 105°C CAP 470UF M 16V
CN601	088G 30210K E	PHONE JACK 5PIN
Q602	057G 414 2	MPS3906
R617	061G 17236252T	3600OHM 5% 1/4W
R607	061G 60210252T	CFR 1K OHM +-5% 1/6W
R608	061G 60210252T	CFR 1K OHM +-5% 1/6W
R619	061G 60210352T	CFR 10KOHM +-5% 1/6W
R620	061G 60210352T	CFR 10KOHM +-5% 1/6W
R621	061G 60210352T	CFR 10KOHM +-5% 1/6W
R622	061G 60210352T	CFR 10KOHM +-5% 1/6W
R603	061G 60218352T	18KOHM 5% 1/6
R601	061G 60218352T	18KOHM 5% 1/6
R610	061G 60220352T	CFR 20K OHM+-5% 1/6W
R611	061G 60220352T	CFR 20K OHM+-5% 1/6W
R602	061G 60220452T	200KOHM 5% 1/6W
R612	061G 60222452T	220KOHM 5% 1/6W
C604	064G178J474 0T6951	CL21X. 0.47UF 50V +-5%
C606	064G178J474 0T6951	CL21X. 0.47UF 50V +-5%
C611	065G 444101 5T	100 PF 10% 50V Y5P
C612	065G 444101 5T	100 PF 10% 50V Y5P

C603	065G 450104 7T	0.1UF +80-20% 50V Y5V
C609	067G215Y1097NT	EC 1.0UF 50V KY50VB1M-TP5 5*11MM
C613	067G215Y1097NT	EC 1.0UF 50V KY50VB1M-TP5 5*11MM
C614	067G215Y1097NT	EC 1.0UF 50V KY50VB1M-TP5 5*11MM
C610	067G215Y1097NT	EC 1.0UF 50V KY50VB1M-TP5 5*11MM
ZD603	093G 39 7752T	HZ5C1-E
D601	093G 64 1152T	1N4148
D602	093G 64 1152T	1N4148
	715G2767 1	AUDIO BOARD PCB FR-1 35*104.5 5PCS/PNL
	Q90G6258 2	HEAT SINK
	CBPC7MMPUSQ1	MAIN BOARD
CN403	033G3802 6	WAFER
CN701	033G3802 9	WAFER 9P RIGHT ANELE PITCH
	040G 45762412B	CBPC LABEL
R702	061G152M339 64	CHIPR 3.3 OHM +-5% 2W
CN405	088G 35315F H	D-SUB 15PIN
X401	093G 2253B H	XAT01431AFI1H-3OHX AT-49 14.31818MHZ
CN407	033G801955Y H HC	0.5 PITCH 55P SMT
U401	056G 562199	IC TSUMO5RCWHQ-LF PQFP-128
U701	056G 56327A	IC AP1117E18LA SOT223-3L ANACHIP
U702	056G 585 4A	AP1117E33LA
U404	056G1133 34	M24C02-WMN6TP
U403	056G1133 89	IC AF24BC16-SI 16K SOIC-8
U402	056G1133713	IC PM25LV010A-100SCE SOIC-8
Q402	057G 417511	MMBT3904
Q406	057G 417511	MMBT3904
Q703	057G 417511	MMBT3904
Q401	057G 417512	MMBT3906
Q403	057G 417512	MMBT3906
Q411	057G 417512	MMBT3906
Q412	057G 763501	FET AM2321P ANALOG POWER
R407	061G0402000	RST CHIPR 0 OHM +-5% 1/16W
R410	061G0402000	RST CHIPR 0 OHM +-5% 1/16W
R411	061G0402101	RST CHIPR 100 OHM +-5% 1/16W
R418	061G0402101	RST CHIPR 100 OHM +-5% 1/16W
R420	061G0402101	RST CHIPR 100 OHM +-5% 1/16W
R427	061G0402101	RST CHIPR 100 OHM +-5% 1/16W
R428	061G0402101	RST CHIPR 100 OHM +-5% 1/16W
R429	061G0402101	RST CHIPR 100 OHM +-5% 1/16W
R441	061G0402101	RST CHIPR 100 OHM +-5% 1/16W

R442	061G0402101	RST CHIPR 100 OHM +-5% 1/16W
R443	061G0402101	RST CHIPR 100 OHM +-5% 1/16W
R453	061G0402101	RST CHIPR 100 OHM +-5% 1/16W
R454	061G0402101	RST CHIPR 100 OHM +-5% 1/16W
R483	061G0402101	RST CHIPR 100 OHM +-5% 1/16W
R488	061G0402101	RST CHIPR 100 OHM +-5% 1/16W
R499	061G0402101	RST CHIPR 100 OHM +-5% 1/16W
R447	061G0402102	RST CHIPR 1 KOHM +-5% 1/16W
R445	061G0402102	RST CHIPR 1 KOHM +-5% 1/16W
R446	061G0402102	RST CHIPR 1 KOHM +-5% 1/16W
R494	061G0402103	RST CHIPR 10 KOHM +-5% 1/16W
R425	061G0402103	RST CHIPR 10 KOHM +-5% 1/16W
R424	061G0402103	RST CHIPR 10 KOHM +-5% 1/16W
R415	061G0402103	RST CHIPR 10 KOHM +-5% 1/16W
R413	061G0402103	RST CHIPR 10 KOHM +-5% 1/16W
R408	061G0402103	RST CHIPR 10 KOHM +-5% 1/16W
R406	061G0402103	RST CHIPR 10 KOHM +-5% 1/16W
R404	061G0402103	RST CHIPR 10 KOHM +-5% 1/16W
R426	061G0402103	RST CHIPR 10 KOHM +-5% 1/16W
R452	061G0402103	RST CHIPR 10 KOHM +-5% 1/16W
R487	061G0402103	RST CHIPR 10 KOHM +-5% 1/16W
R489	061G0402103	RST CHIPR 10 KOHM +-5% 1/16W
R490	061G0402103	RST CHIPR 10 KOHM +-5% 1/16W
R708	061G0402103	RST CHIPR 10 KOHM +-5% 1/16W
R497	061G0402103	RST CHIPR 10 KOHM +-5% 1/16W
R431	061G0402103	RST CHIPR 10 KOHM +-5% 1/16W
R711	061G0402103	RST CHIPR 10 KOHM +-5% 1/16W
R493	061G0402103	RST CHIPR 10 KOHM +-5% 1/16W
R448	061G0402222	RST CHIPR 2.2 KOHM +-5% 1/16W
R449	061G0402222	RST CHIPR 2.2 KOHM +-5% 1/16W
R405	061G0402223	RST CHIPR 22 KOHM +-5% 1/16W
R403	061G0402390 0F	RST CHIP 390R 1/16W 1%
R474	061G0402390 1F	RST CHIPR 3.9KOHM +-1% 1/16W
R475	061G0402390 1F	RST CHIPR 3.9KOHM +-1% 1/16W
R419	061G0402471	RST CHIPR 470 OHM +-5% 1/16W
R421	061G0402471	RST CHIPR 470 OHM +-5% 1/16W
R437	061G0402471	RST CHIPR 470 OHM +-5% 1/16W
R451	061G0402472	RST CHIPR 4.7 KOHM +-5% 1/16W
R450	061G0402472	RST CHIPR 4.7 KOHM +-5% 1/16W
R496	061G0402472	RST CHIPR 4.7 KOHM +-5% 1/16W

R712	061G0402472	RST CHIPR 4.7 KOHM +-5% 1/16W
R444	061G0402472	RST CHIPR 4.7 KOHM +-5% 1/16W
R433	061G0402472	RST CHIPR 4.7 KOHM +-5% 1/16W
R423	061G0402472	RST CHIPR 4.7 KOHM +-5% 1/16W
R422	061G0402472	RST CHIPR 4.7 KOHM +-5% 1/16W
R495	061G0402513	RST CHIP 51K 1/16W 5%
R434	061G0402560	RST CHIP 56R 1/16W 5%
R435	061G0402560	RST CHIP 56R 1/16W 5%
R436	061G0402560	RST CHIP 56R 1/16W 5%
R438	061G0402750	RST CHIPR 75 OHM +-5% 1/16W
R439	061G0402750	RST CHIPR 75 OHM +-5% 1/16W
R440	061G0402750	RST CHIPR 75 OHM +-5% 1/16W
FB401	061G0603000	RST CHIPR 0 OHM +-5% 1/10W
FB410	061G0603000	RST CHIPR 0 OHM +-5% 1/10W
FB411	061G0603000	RST CHIPR 0 OHM +-5% 1/10W
FB412	061G0603000	RST CHIPR 0 OHM +-5% 1/10W
R491	061G0805391	390 OHM 1/10W 1%
C435	065G0402102 32	1000PF +-10% 50V X7R
C410	065G0402104 15	MLCC 0402 0.1UF K 16V X5R
C409	065G0402104 15	MLCC 0402 0.1UF K 16V X5R
C407	065G0402104 15	MLCC 0402 0.1UF K 16V X5R
C406	065G0402104 15	MLCC 0402 0.1UF K 16V X5R
C411	065G0402104 15	MLCC 0402 0.1UF K 16V X5R
C412	065G0402104 15	MLCC 0402 0.1UF K 16V X5R
C440	065G0402104 15	MLCC 0402 0.1UF K 16V X5R
C441	065G0402104 15	MLCC 0402 0.1UF K 16V X5R
C456	065G0402104 15	MLCC 0402 0.1UF K 16V X5R
C457	065G0402104 15	MLCC 0402 0.1UF K 16V X5R
C458	065G0402104 15	MLCC 0402 0.1UF K 16V X5R
C701	065G0402104 15	MLCC 0402 0.1UF K 16V X5R
C704	065G0402104 15	MLCC 0402 0.1UF K 16V X5R
C709	065G0402104 15	MLCC 0402 0.1UF K 16V X5R
C711	065G0402104 15	MLCC 0402 0.1UF K 16V X5R
C713	065G0402104 15	MLCC 0402 0.1UF K 16V X5R
C714	065G0402104 15	MLCC 0402 0.1UF K 16V X5R
C462	065G0402104 15	MLCC 0402 0.1UF K 16V X5R
C465	065G0402104 15	MLCC 0402 0.1UF K 16V X5R
C413	065G0402104 15	MLCC 0402 0.1UF K 16V X5R
C414	065G0402104 15	MLCC 0402 0.1UF K 16V X5R
C415	065G0402104 15	MLCC 0402 0.1UF K 16V X5R

C416	065G0402104 15	MLCC 0402 0.1UF K 16V X5R
C419	065G0402104 15	MLCC 0402 0.1UF K 16V X5R
C420	065G0402104 15	MLCC 0402 0.1UF K 16V X5R
C422	065G0402104 15	MLCC 0402 0.1UF K 16V X5R
C426	065G0402104 15	MLCC 0402 0.1UF K 16V X5R
C427	065G0402104 15	MLCC 0402 0.1UF K 16V X5R
C428	065G0402104 15	MLCC 0402 0.1UF K 16V X5R
C429	065G0402104 15	MLCC 0402 0.1UF K 16V X5R
C430	065G0402104 15	MLCC 0402 0.1UF K 16V X5R
C439	065G0402104 15	MLCC 0402 0.1UF K 16V X5R
C405	065G0402104 15	MLCC 0402 0.1UF K 16V X5R
C404	065G0402104 15	MLCC 0402 0.1UF K 16V X5R
C402	065G0402104 15	MLCC 0402 0.1UF K 16V X5R
C401	065G0402104 15	MLCC 0402 0.1UF K 16V X5R
C463	065G0402105 A5	CAP 0402 1UF K 10V X5R
C443	065G0402221 31	CAP:CER 220PF 5% 50V SM
C444	065G0402224A5T	MLCC 0402 0.22UF K 10V X
C417	065G0402224A5T	MLCC 0402 0.22UF K 10V X
C425	065G0402224A5T	MLCC 0402 0.22UF K 10V X
C423	065G0402270 31	0402 27PF J 50V NPO
C421	065G0402270 31	0402 27PF J 50V NPO
C442	065G0402330 31	33PF +-50% 50V NPO
C438	065G0402473 12	CHIP 0.047UF 16V X7R
C437	065G0402473 12	CHIP 0.047UF 16V X7R
C432	065G0402473 12	CHIP 0.047UF 16V X7R
C433	065G0402473 12	CHIP 0.047UF 16V X7R
C434	065G0402473 12	CHIP 0.047UF 16V X7R
C436	065G0402473 12	CHIP 0.047UF 16V X7R
FB409	071G 56G151 MD	CHIP BEAD
FB421	071G 56K121	CHIP BEAD
FB402	071G 56K121	CHIP BEAD
FB403	071G 56K121	CHIP BEAD
FB405	071G 56K121	CHIP BEAD
D407	093G 64 42 P	BAV70 SOT23 BY PAN JIT
D405	093G 6433P	BAV99
D404	093G 6433P	BAV99
D403	093G 6433P	BAV99
D412	093G 39S 24 T	RLZ 5.6B LLDS
D411	093G 39S 24 T	RLZ 5.6B LLDS
D409	093G 39S 24 T	RLZ 5.6B LLDS

D408	093G 39S 24 T	RLZ 5.6B LLDS
D406	093G 39S 24 T	RLZ 5.6B LLDS
D410	093G 39S 34 T	UDZSNP5.6B ROHM
D401	093G 39S 34 T	UDZSNP5.6B ROHM
D402	093G 39S 34 T	UDZSNP5.6B ROHM
D704	093G2004 2	DIODE SR24
	715G2670 1 2	MAIN BOARD PCB FR4 80X67X1.6MM DS
	KEPC7QU1	KEY BOARD
SW002	077G 605 1 CJ	TSAB-2
SW001	077G 605 1 CJ	TSAB-2
SW005	077G 605 1 CJ	TSAB-2
SW006	077G 605 1 CJ	TSAB-2
SW004	077G 605 1 CJ	TSAB-2
SW003	077G 605 1 CJ	TSAB-2
CN001	033G8032 6F HR	CONNECTOR
R005	061G0603000	RST CHIPR 0 OHM +-5% 1/10W
R002	061G0603000	RST CHIPR 0 OHM +-5% 1/10W
R003	061G0603100 1F	RST CHIPR 1 KOHM +-1% 1/10W
R004	061G0603200 1F	RST CHIPR 2 KOHM +-1% 1/10W
R001	061G0603200 1F	RST CHIPR 2 KOHM +-1% 1/10W
C003	065G0603104 37	CHIP 0.1UF 50V/Y5V
C005	065G0603104 37	CHIP 0.1UF 50V/Y5V
C001	065G0603104 37	CHIP 0.1UF 50V/Y5V
C002	065G0603104 37	CHIP 0.1UF 50V/Y5V
C004	065G0603104 37	CHIP 0.1UF 50V/Y5V
LED01	081G 14 12 GP	LED
ZD003	093G 39S 24 T	RLZ 5.6B LLDS
ZD001	093G 39S 24 T	RLZ 5.6B LLDS
ZD002	093G 39S 24 T	RLZ 5.6B LLDS
	715G2900 1	KEY BOARD PCB FR4 147X12X1.6MM DS
	PWPC7C42CQD3	POWER BOARD
GND1	009G6005 1	GROUND TERMINAL
CN801	033G8021 2E F	WAFER
CN802	033G8021 2E F	WAFER
CN803	033G8021 2E F	WAFER
CN804	033G8021 2E F	WAFER
	040G 45762420A	LABEL 25X6MM
	051G 6 4503	GLUE_RTV
IC903	056G 139 3A	IC PC123Y22FZ0F
NR901	061G 58080 WT	8 OHM NCT

R908	061G152M104 64	100KOHM 5% 2W
R914	061G152M228 64	0.22 OHM 5% 2W
C903	063G107K474 6S	CAP X2 0.47UF K 275VAC
C801	065G 6J5096ET	CAP CER 5PF J 6KV
C811	065G 6J5096ET	CAP CER 5PF J 6KV
C902	065G305M1022BP	Y2 1000PF M 250VAC Y5P
C901	065G305M1022BP	Y2 1000PF M 250VAC Y5P
C921	065G306M4722BP	4700PF +-20% 400VAC
C803	067G215D4714KV	E.C 105°C CAP 470UF M 25V ED SERIES
C802	067G215D4714KV	E.C 105°C CAP 470UF M 25V ED SERIES
C918	067G215D6814KV	CAP 105°C 680UF M 25V
C917	067G215D6814KV	CAP 105°C 680UF M 25V
C939	067G215S1024KV	EC 105°C CAP 1000UF M 25V
C915	067G215S4713KV	EC 105°C CAP 470UF M 16V
C905	067G215Z12115K	ELCAP 105°C 120UF M 450V
L902	073G 174 65 H	LINE FILTER
L901	073G 174 76 H	FILTER
L903	073G 253191 YS	CHOKER COIL 1.1UH YS04110055
L904	073G 253191 YS	CHOKER COIL 1.1UH YS04110055
T901	080GL19T 23 YS	X'FMR 510UH YS04160061
T801	080GL19T 24 YS	X'FMR 740MH YS04170157
T802	080GL19T 24 YS	X'FMR 740MH YS04170157
CN901	087G 501 37 S	AC INLET ST-01DG-B2K-K
BD901	093G 50460 28	BRIDGE DIODE KBP208G LITEON
CN902	095G 825 9D 1	HARNESS 9P(SCN)-9P+6P 230MM
	705G 193 57 01	Q901 ASS'Y
	051G 200 1	OIL FOR DISAPPEAR
Q901	057G 667 21	STP10NK70ZFP
	090G6263 1	HEAT SINK
	AM1G1730 8120 GP	SCREW
	705G 193 93 01	D906 ASS'Y
	051G 200 1	OIL FOR DISAPPEAR
D906	093G 60218	SB10100FCT
	AM1G1730 8120 GP	SCREW
	Q90G6274 2	HEAT SINK
	705GQ9KA 93002	D905 ASS'Y
	051G 200 1	OIL FOR DISAPPEAR
	090G6084 1	HEAT SINK
D905	093G 60257	DIODE SB1060FCT ITO-220AB BY PAN JIT
	0M1G1730 8120	SCREW

IC801	056G 379 22	IC TL494IDR SOIC-16
IC901	056G 379 71	IC TEA1530AT/N2 SO-8 NXP
Q801	057G 417 4	PMBS3904/PHILIPS-SMT(04)
Q806	057G 417 4	PMBS3904/PHILIPS-SMT(04)
Q807	057G 417 4	PMBS3904/PHILIPS-SMT(04)
Q811	057G 417 4	PMBS3904/PHILIPS-SMT(04)
Q902	057G 417 4	PMBS3904/PHILIPS-SMT(04)
Q812	057G 417 6	PMBS3906/PHILIPS-SMT(06)
Q804	057G 417 6	PMBS3906/PHILIPS-SMT(06)
Q809	057G 759 2	RK7002
Q810	057G 759 2	RK7002
Q808	057G 760 4B	PDTA144WK SOT346
Q805	057G 760 5B	PDTC144WK SOT346
Q802	057G 763 14	AM9945N
Q803	057G 763 14	AM9945N
R809	061G0603100 1F	RST CHIPR 1 KOHM +-1% 1/10W
R812	061G0603100 1F	RST CHIPR 1 KOHM +-1% 1/10W
R818	061G0603100 1F	RST CHIPR 1 KOHM +-1% 1/10W
R821	061G0603100 1F	RST CHIPR 1 KOHM +-1% 1/10W
R822	061G0603100 1F	RST CHIPR 1 KOHM +-1% 1/10W
R824	061G0603100 1F	RST CHIPR 1 KOHM +-1% 1/10W
R826	061G0603100 1F	RST CHIPR 1 KOHM +-1% 1/10W
R925	061G0603100 1F	RST CHIPR 1 KOHM +-1% 1/10W
R942	061G0603100 1F	RST CHIPR 1 KOHM +-1% 1/10W
R926	061G0603100 2F	RST CHIPR 10 KOHM +-1% 1/10W
R834	061G0603100 2F	RST CHIPR 10 KOHM +-1% 1/10W
R833	061G0603100 2F	RST CHIPR 10 KOHM +-1% 1/10W
R832	061G0603100 2F	RST CHIPR 10 KOHM +-1% 1/10W
R828	061G0603100 2F	RST CHIPR 10 KOHM +-1% 1/10W
R817	061G0603100 2F	RST CHIPR 10 KOHM +-1% 1/10W
R813	061G0603100 2F	RST CHIPR 10 KOHM +-1% 1/10W
R808	061G0603100 2F	RST CHIPR 10 KOHM +-1% 1/10W
R835	061G0603105	RST CHIPR 1 MOHM +-5% 1/10W
R862	061G0603105	RST CHIPR 1 MOHM +-5% 1/10W
R861	061G0603130 3F	RST CHIPR 130KOHM +-1% 1/10W
R801	061G0603150 1F	RST CHIPR 1.5 KOHM +-1% 1/10W
R814	061G0603150 1F	RST CHIPR 1.5 KOHM +-1% 1/10W
R815	061G0603150 1F	RST CHIPR 1.5 KOHM +-1% 1/10W
R816	061G0603150 1F	RST CHIPR 1.5 KOHM +-1% 1/10W
R924	061G0603152	RST CHIPR 1.5 KOHM +-5% 1/10W

R811	061G0603240 1F	RST CHIPR 2.4 KOHM +-1% 1/10W
R831	061G0603240 1F	RST CHIPR 2.4 KOHM +-1% 1/10W
R930	061G0603240 1F	RST CHIPR 2.4 KOHM +-1% 1/10W
R940	061G0603330 2F	RST CHIPR 33 KOHM +-1% 1/10W
R927	061G0603360 1F	RST CHIPR 3.6 KOHM +-1% 1/10W
R827	061G0603362	RST CHIPR 3.6 KOHM +-5% 1/10W
R823	061G0603362	RST CHIPR 3.6 KOHM +-5% 1/10W
R819	061G0603362	RST CHIPR 3.6 KOHM +-5% 1/10W
R820	061G0603470 2F	RST CHIPR 47 KOHM +-1% 1/10W
R803	061G0603564	RST CHIPR 560 KOHM +-5% 1/10W
R806	061G0603680 2F	RST CHIPR 68 KOHM +-1% 1/10W
R807	061G0603680 2F	RST CHIPR 68 KOHM +-1% 1/10W
R841	061G0603680 2F	RST CHIPR 68 KOHM +-1% 1/10W
R853	061G0603680 2F	RST CHIPR 68 KOHM +-1% 1/10W
R854	061G0603680 2F	RST CHIPR 68 KOHM +-1% 1/10W
R851	061G0603820 1F	RST CHIPR 8.2 KOHM +-1% 1/10W
R850	061G0805000	0 OHM 1/10W
R839	061G0805000	0 OHM 1/10W
R804	061G0805101	RST CHIPR 100 OHM +-5% 1/8W
R911	061G0805102	RST CHIPR 1KOHM +-5% 1/8W
R917	061G0805102	RST CHIPR 1KOHM +-5% 1/8W
R929	061G0805102	RST CHIPR 1KOHM +-5% 1/8W
R938	061G0805103	10 KOHM 1/10W
R916	061G0805152	RST CHIPR 1.5 KOHM +-5% 1/8W
R829	061G0805220	22&8 1/10W
R825	061G0805220	22&8 1/10W
R912	061G0805220 2F	RST CHIPR 22 KOHM +-1% 1/8W
R915	061G0805224	RST CHIPR 220 KOHM +-5% 1/8W
R837	061G0805473	RST CHIPR 47 KOHM +-5% 1/8W
R810	061G0805510 2F	RST CHIPR 51 KOHM +-1% 1/8W
R931	061G0805822	RST CHIPR 8.2 KOHM +-5% 1/8W
JR801	061G1206000	RST CHIPR 0 OHM +-5% 1/4W
JR802	061G1206000	RST CHIPR 0 OHM +-5% 1/4W
JR803	061G1206000	RST CHIPR 0 OHM +-5% 1/4W
JR804	061G1206000	RST CHIPR 0 OHM +-5% 1/4W
JR805	061G1206000	RST CHIPR 0 OHM +-5% 1/4W
JR807	061G1206000	RST CHIPR 0 OHM +-5% 1/4W
JR808	061G1206000	RST CHIPR 0 OHM +-5% 1/4W
JR809	061G1206000	RST CHIPR 0 OHM +-5% 1/4W
JR901	061G1206000	RST CHIPR 0 OHM +-5% 1/4W

R967	061G1206000 4	RST CHIPR 0 OHM +-5% 1/4W
F902	061G1206000 4	RST CHIPR 0 OHM +-5% 1/4W
F801	061G1206000 4	RST CHIPR 0 OHM +-5% 1/4W
R909	061G1206100	RST CHIP 10R 1/4W 5%
R910	061G1206100	RST CHIP 10R 1/4W 5%
R918	061G1206101	100 1206
R919	061G1206101	100 1206
R920	061G1206101	100 1206
R935	061G1206101	100 1206
R961	061G1206101	100 1206
R962	061G1206101	100 1206
R921	061G1206102	RST CHIPR 1 KOHM +-5% 1/4W
R922	061G1206102	RST CHIPR 1 KOHM +-5% 1/4W
R923	061G1206102	RST CHIPR 1 KOHM +-5% 1/4W
R928	061G1206102	RST CHIPR 1 KOHM +-5% 1/4W
R855	061G1206150	RST CHIPR 15 OHM +-5% 1/4W
R857	061G1206150	RST CHIPR 15 OHM +-5% 1/4W
R856	061G1206150	RST CHIPR 15 OHM +-5% 1/4W
R858	061G1206150	RST CHIPR 15 OHM +-5% 1/4W
R904	061G1206472	RST CHIPR 4.7 KOHM +-5% 1/4W
R932	061G1206472	RST CHIPR 4.7 KOHM +-5% 1/4W
R933	061G1206472	RST CHIPR 4.7 KOHM +-5% 1/4W
R901	061G1206684	RST CHIPR 680 KOHM +-5% 1/4W
R902	061G1206684	RST CHIPR 680 KOHM +-5% 1/4W
R903	061G1206684	RST CHIPR 680 KOHM +-5% 1/4W
C842	065G0603103 12	CHIP 0.01UF 16V X7R
C924	065G0603103 12	CHIP 0.01UF 16V X7R
C834	065G0603104 22	CHIP 0.1UF 25V X7R
C825	065G0603104 22	CHIP 0.1UF 25V X7R
C821	065G0603104 22	CHIP 0.1UF 25V X7R
C807	065G0603104 22	CHIP 0.1UF 25V X7R
C823	065G0603222 22	CHIP 2200PF 25V X7R
C819	065G0603222 22	CHIP 2200PF 25V X7R
C816	065G0603222 22	CHIP 2200PF 25V X7R
C815	065G0603222 22	CHIP 2200PF 25V X7R
C910	065G0805102 32	CHIP 1000P 50VX7R 0805
C931	065G0805104 32	CHIP 0.1U 50V X7R
C930	065G0805104 32	CHIP 0.1U 50V X7R
C916	065G0805104 32	CHIP 0.1U 50V X7R
C907	065G0805104 32	CHIP 0.1U 50V X7R

C824	065G0805104 32	CHIP 0.1U 50V X7R
C805	065G0805104 32	CHIP 0.1U 50V X7R
C822	065G0805105 22	CHIP 1UF 25V X7R 0805
C928	065G0805122 31	CHIP CAP 0805 1200PF J 50V NPO
C841	065G0805152 31	1.5NF/50V
C838	065G0805152 31	1.5NF/50V
C840	065G0805152 31	1.5NF/50V
C839	065G0805152 31	1.5NF/50V
C820	065G080522131G	220PF 50V NPO 2%
C911	065G0805224 22	CAIP CAP 0.22 UF 25V X7R
C909	065G0805224 32	0.22UF,K,50V,X7R
C845	065G0805225 12	CHIP 2.2UF 16V X7R 0805
C912	065G1206102 72	CHIP 1000PF 500V X7R
C929	065G1206102 72	CHIP 1000PF 500V X7R
D805	093G 64 38 P	BAW56
D808	093G 64 38 P	BAW56
D903	093G 64 38 P	BAW56
D916	093G 6432S	IN4148W
D915	093G 6432S	IN4148W
D817	093G 6432S	IN4148W
D814	093G 6432S	IN4148W
D809	093G 6432S	IN4148W
D806	093G 6432S	IN4148W
D801	093G 6433P	BAV99
D802	093G 6433P	BAV99
D803	093G 6433P	BAV99
D804	093G 6433P	BAV99
ZD922	093G 39S 25 T	RLZ5.1B LLDS
ZD902	093G 39S 61 T	DIODE RLZ16B ROHM
ZD921	093G 39S 61 T	DIODE RLZ16B ROHM
CN901	006G 31500	EYELET
T901	006G 31502	1.5MM RIVET
NR901	006G 31502	1.5MM RIVET
IC904	056G 158 12	KIA431A-AT/P TO-92
C906	065G 2K152 1T6052	1.5NF/2KV Y5P +-10%
C938	065G 2K152 1T6052	1.5NF/2KV Y5P +-10%
C908	067G215Y2207KT	CAP 105°C 22UF M 50V KINGNICH
FB901	071G 55 29	FERRITE BEAD
F901	084G 55 1W	FUSE 4A 250V WICKMANN
D901	093G 6038P52T	PS102R

D900	093G1100 1152T	DIODE PR1007R 1A/1000V DO-41
	715G2538 4	POWER BOARD PCB FR-1 160*124MM SS
	Q07G 8 3 54	COMPOUND PALLET
	Q15G0267101	SHIELDING
	Q33G0180 1	WEBCAM MYLAR
	Q40G0001624 4A	PALLET LABEL
	Q40G000268067A	SPLENDID LABEL FOR VK222S
	Q40G000268070A	TRY ME LABEL FOR VK22
	Q41G780068025C	EU WARRANTY CARD NON ZBD
	Q44G6002CP215A	PAPER CAP
	Q44GC037680 2A	22 LCD ASUS CARTON
	Q44GC048101	EPS
	Q44GC048201	EPS
	Q45G 76 28V13 R	PE BAG
	Q45G 88606 S R	PE BAG FOR BASE
	Q45G 88609 74	EPE BAG
	Q52G6020 29	PROTECT FILM
	Q90G0150 1	HEAT SINK
	USB7QU1	USB BOARD
CN003	033G3802 5H	WAFER 5P RIGHT ANELE PITCH
CN002	088G 351 2B TN	USB CONN
R007	061G0603000	RST CHIPR 0 OHM +-5% 1/10W
R006	061G0603000	RST CHIPR 0 OHM +-5% 1/10W
C007	065G0603104 37	CHIP 0.1UF 50V/Y5V
C006	065G0603104 37	CHIP 0.1UF 50V/Y5V
C008	065G1206106 17	MLCC 10 UF Z 16V Y5V
FB001	071G 56K121 M	CHIP BEAD
ZD005	093G 64 49 SU	DIODE ESD EGA 10603V05A1-B INPAQ
ZD004	093G 64 49 SU	DIODE ESD EGA 10603V05A1-B INPAQ
	715G2901 1	SIDE BOARD PCB FR-4 22X37X1.6MM DS
	045G 76 28 RN	PE BAG FOR MANUAL
	070G2000500 AS	CD-ROM
	Q41G780068040A	VK221 222 QSG
	040G 457834 4A GP	S/N LABEL FOR ID
	040G 457842 2B	PALLET LABEL
	040G 58162435A	P/N LABEL
	040G 582680 3A	PALLET LABEL
	040G 582680 4A	CARTON LABEL
	Q40G 22N68010A	RATING LABEL

12. Different Parts List

for VK222U

Diversity of TC72MPFCW3USDI Compared with TC72MPFKW3USDI		
Location	Part No. for TPV	Description
	089G404A18N LS	POWER CORD
	089G410A18N LS	POWER CORD
	089G412A18NYH3	POWER CORD
C906	065G 2K152 1T6213	CAP CER 1500PF K 2KV
C938	065G 2K152 1T6213	CAP CER 1500PF K 2KV
	Q40G 22N68010A	RATING LABEL
	Q41G780068031C	APAC WARRANTY CARD NON ZBD
	Q41G780A61564A	TCO06 CARD

for VK222S

Diversity of TC72MPFBW3UEAI Compared with TC72MPFBW3USAI		
Location	Part No. for TPV	Description
	089G410A18N IS	POWER CORD 32E1818020
C906	065G 2K152 1T6213	CAP CER 1500PF K 2KV
C938	065G 2K152 1T6213	CAP CER 1500PF K 2KV
	Q41G780A61564A	TCO06 CARD

Diversity of TC72MPFTW3USAQ Compared with TC72MPFKW3USDI		
Location	Part No. for TPV	Description
	040G 582680 1A	CARTON LABEL
	089G402A18N IS	POWER CORD/(TPV 共用)32-D022438
C906	065G 2K152 1T6213	CAP CER 1500PF K 2KV
C938	065G 2K152 1T6213	CAP CER 1500PF K 2KV
	Q40G000268072A	SPLENDID ZBD LABEL FOR VK222S
	Q41G780068029B	TW WARRANTY CARD ZBD
	Q41G780068041A	VK221 222 QSG FOR NON EU
	Q41G780A61564A	TCO06 CARD